

HOT SPOT<sup>®</sup>



## HOT SPOT<sup>®</sup> SPAS

Tempo<sup>®</sup> • Rhythm<sup>®</sup> • Relay<sup>®</sup> • SX • TX

OWNER'S MANUAL

From the makers of



# HOT SPOT



***Watkins Manufacturing Corporation congratulates you on your decision to enjoy the finest spa available... Welcome to the growing family of Hot Spot® spa owners.***

Before you begin reviewing the manual, please take a moment to register your warranty. By doing so will help assist us in contacting you for any important product notifications, and help ensure that you and others can enjoy quality products for years to come.

Prior to registering, you will need the serial number that is located within the equipment compartment of your **HOT SPOT** spa.

To register please go to <http://www.HotSpring.com/owners/product-registration> or simply scan the QR code below:

FOR YOUR RECORDS



Spa Model/Serial Number: \_\_\_\_\_

Date Purchased: \_\_\_\_\_

Dealer: \_\_\_\_\_

Address: \_\_\_\_\_

Cover Serial Number: \_\_\_\_\_

Accessory Serial Number: \_\_\_\_\_

If you have any questions about any aspect of your spa's set-up, operation or maintenance, contact your authorized **HOT SPOT** dealership. They are trained professionals who are familiar with the product as well as new spa ownership concerns. Their expertise will facilitate the enjoyment of your new **HOT SPOT** spa.

Important: Watkins manufacturing Corporation reserves the right to change specifications, or design, without notification and without incurring any obligation.



In most cities and counties, permits will be required for the installation of electrical circuits or the construction of exterior surfaces (decks and gazebos). In addition, some communities have adopted residential barrier codes which may require fencing and/or self-closing gates on the property to prevent unsupervised access to a pool (or spa) by children under 5 years of age. Your **HOT SPOT** spa is equipped with a locking cover that meets the ASTM F1346-91 Standard for Safety Covers and as a result, is usually exempt from most barrier requirements. As a general practice, your local Building Department will inform you of any applicable barrier requirements at the time a permit is obtained for the installation of an electrical circuit. Your **HOT SPOT** dealer can provide information on which permits may be required.

# TABLE OF CONTENTS

## **SAFETY INFORMATION**

Important Safety Instructions .....	1
Important Spa Instructions .....	3

## **INSTALLATION INSTRUCTIONS**

Site Preparation .....	4
Outdoor Installation and Patio Installation .....	4
Deck Installation .....	4
Indoor/Basement Installation .....	4
Spa Leveling Preparation .....	5
Spa Cover Installation .....	5

## **ELECTRICAL INSTALLATION**

Selecting the Voltage for your Spa .....	5
115 Volt 30 Amp Conversion (SX & TX Models) .....	6
230 Volt Wiring Conversion 50 amp (SX & TX Models). 7	
230 Volt Wiring Instructions (Tempo®, Relay® & Rhythm® Models) .....	9

## **SPA SPECIFICATIONS & ILLUSTRATION**

<b>TEMPO</b> (Model TEM) .....	10
<b>RELAY</b> (Model REL) .....	11
<b>RHYTHM</b> (Model RHY ) .....	12
SX (Model SX) .....	13
TX (Model TX) .....	14

## **OPERATING INSTRUCTIONS**

Start-up and Refill Procedures .....	15
Heating and Hydromassage Systems .....	16
Safety Equipment .....	17
Spa Control Panel Operations for the <b>TEMPO, RELAY,</b> <b>RHYTHM</b> spas Only .....	17
System Mode .....	18
Cleaning .....	18
Tools Menu .....	18
Audio Menu (Optional) .....	20
Spa Control Panel Operations for the SX & TX spas Only ..	22
System Mode .....	23
Cleaning .....	23
Tools Menu .....	23

Audio Menu (Optional) .....	25
-----------------------------	----

## **JET MENUS**

<b>TEMPO</b> (Model TEM) .....	28
<b>RELAY</b> (Model REL) .....	29
<b>RHYTHM</b> (Model RHY ) .....	30
SX (Model SX) .....	31
TX (Model TX) .....	32

## **WATER QUALITY AND MAINTENANCE**

General Information .....	33
Methods for Testing the Spa Water .....	33
<b>HOT SPOT</b> Spa Water Maintenance Program .....	34
Freshwater Ag+® Silver Ion System .....	36
EverFresh® Water Care System .....	36
<b>HOT SPOT</b> Water Treatment Guide .....	37
Ozone (Optional) .....	40
Common Water Chemistry Questions .....	40
Water Terminology .....	41

## **MAINTENANCE AND SPA CARE**

Filter Maintenance .....	41
Care of Spa Pillow .....	42
Care of the Spa Shell .....	42
Care of the Spa Cover .....	42
Care of the Spa Cabinet .....	43
Draining your Spa .....	43
Non-Operation in Cold Climate .....	43
Winterizing your Spa .....	44

## **SERVICE INFORMATION**

General Information .....	45
GFCI and High Limit Thermostat .....	45
Miscellaneous Service Information .....	45
Acts Invalidating Warranty .....	45
Disclaimers .....	46
Watkins Customer Service .....	46
Troubleshooting .....	46
Priming the Pumps .....	48

# SAFETY INFORMATION

## IMPORTANT SAFETY INSTRUCTIONS

*(Read and follow all instructions)*

### AVOIDING THE RISK TO CHILDREN

#### **WARNING:**

- RISK OF CHILD DROWNING. Extreme caution must be exercised to prevent unauthorized access by children. To avoid accidents, ensure that children cannot use a spa unless they are supervised at all times.
- To reduce the risk of injury, do not permit children to use this product unless they are closely supervised at all times.
- To reduce the risk of injury, lower water temperatures are recommended for young children. Children are especially sensitive to hot water.

#### **DO:**

- Make sure you always lock the child resistant locks after using the spa for your children's safety. Every **HOT SPOT** is equipped with a locking cover that meets the ASTM F1346-91 Standard for Safety Covers.
- Test the water temperature with your hand before allowing your child to enter the spa to be sure that it's comfortable. Children are especially sensitive to hot water.
- Remind children that wet surfaces can be very slippery. Make sure that the children are careful when entering or exiting the spa.

#### **DON'T:**

- Allow children to climb onto the spa cover.
- Allow children to have unsupervised access to the spa.

### AVOIDING THE RISK OF ELECTROCUTION

#### RISK OF ELECTROCUTION

- Connect only to a grounded source.
- Do not bury the power cord. A buried power cord may result in death or serious personal injury due to electrocution if direct burial-type cable is not used, or if improper digging occurs.
- A ground terminal (pressure wire connector) is provided on the control box inside the unit to permit connection of a minimum No. 10 AWG (6mm<sup>2</sup>) solid copper bonding conductor between this point and any metal equipment, metal water pipe, metal enclosures of electrical equipment, or conduit within five feet (1.5 m) of the unit as needed to comply with local requirements.

#### **WARNING:**

- To reduce the risk of electrical shock, replace a damaged cord immediately. Failure to do so may result in death or serious personal injury due to electrocution.
- Your spa is provided with a Ground Fault Circuit Interrupter for user and equipment protection. To ensure proper operation of this important safety device, test according to the following instructions per electrical configuration.

**Cord-Connected 115 volt 15 or 20 amp models:** The GFCI is located at the end of the power cord. Before each use, with the unit operating, push the TEST button. The unit should stop operating and the GFCI power indicator will go out. Wait 30 seconds and then reset the GFCI by pushing the RESET button. The GFCI power indicator will turn on, restoring power to the spa. If the interrupter does not perform in this manner, there may be an electrical malfunction and with it, the possibility of an electric shock. Disconnect the power until the problem has been corrected.

**115 volt 30 amp hard wired, 230 volt permanently installed or converted models:**

- A ground terminal is provided on the terminal block located inside the control box. To reduce the risk of electric shock, connect this terminal to the grounding terminal of your electrical service or supply panel with a continuous green, insulated copper wire. The wire must be equivalent in size to the circuit conductors supplying the equipment. In addition, a bonding terminal (pressure wire connector) is provided on the outside of the control box for bonding to local ground points. To reduce the risk of electric shock, this connector should be bonded with a No. 8 AWG (8.4 mm<sup>2</sup>) solid copper wire to any metal ladders, water pipes, or other metal within 5 feet (1.5 m) of the spa to comply with local requirements. The means of disconnection must be readily accessible, but must be installed at least 5 feet (1.5 m) from the spa.
- Your spa is provided with a suitably rated circuit breaker to open all ungrounded supply conductors.
- Your spa uses ground fault circuit interrupters in the electrical subpanel. Before each use of the spa and with the unit operating, push the Test button on each breaker. The switch should click over to the "Trip" position. Wait 30 seconds and reset each GFCI breaker by switching it completely off and then completely on. The switch should then stay on. If either of the interrupters does not perform in this manner, it is an indication of an electrical malfunction and the possibility of an electric shock. Disconnect the power until the fault has been identified and corrected.

## **⚠ DANGER: RISK OF ELECTRICAL SHOCK**

- Install at least 5 feet (1.5 m) from all metal surfaces. A spa may be installed within 5 feet (1.5m) of a metal surface if each metal surface is permanently connected by a minimum No. 8AWG (8.4mm<sup>2</sup>) solid copper conductor attached to the wire ground connector on the terminal box that is provided for this purpose if in accordance with National Electrical Code ANSI/NMFA70-1993.
- Do not permit any electrical appliances, such as a light, telephone, radio, or television within 5 feet (1.5 m) of a spa. Failure to maintain a safe distance may result in death or serious personal injury due to electrocution if the appliance should fall into the spa.

### **DO:**

- Be sure your spa is connected to the power supply correctly - use a licensed contractor.
- Disconnect the spa from the power supply before draining the spa or servicing the electrical components.
- Test the Ground Fault Circuit Interrupter(s) before each use.

### **DON'T:**

- Use the spa with the equipment compartment door removed.
- Place electrical appliances within 5 feet (1.5m) of the spa.
- Use an extension cord to connect the spa to its power source. The cord may not be properly grounded and the connection is a shock hazard. An extension cord may cause a voltage drop, which will cause overheating of the jet pump motor and motor damage.
- Attempt to open the electrical control box. There are no user serviceable parts inside.

## **RISKS TO AVOID**

### **⚠ DANGER: RISK OF INJURY**

- DO NOT sit in the filter compartment area. Sitting in this area can cause:  
a) Restriction of Filter Pump suction/vacuum                      b) Damage to components  
Both can result in bodily harm. Should damage occur to components in this area, replace immediately!
- To reduce the risk of injury to persons, DO NOT remove suction fittings (filter standpipes) located in the filter compartment.
- The suction fittings in the spa are sized to match the specific water flow created by the pump. Should the need arise to replace the suction fittings, or the pump, be sure that the flow rates are compatible.
- There is a danger of slipping and falling. Remember that wet surfaces can be very slippery. Take care when entering or exiting the spa.
- People with infectious diseases should not use the spa.
- Keep any loose articles of clothing, long hair or hanging jewelry away from rotating jets or other moving components.

## **INCREASED SIDE EFFECTS OF MEDICATION**

- The use of drugs, alcohol, or medication before or during spa use may lead to unconsciousness with the possibility of drowning.
- Persons using medications should consult a physician before using a spa; some medication may cause a user to become drowsy, while other medication may affect heart rate, blood pressure, and circulation.
- Persons taking medications that induce drowsiness, such as tranquilizers, antihistamines, or anticoagulants should not use the spa.

## **HEALTH PROBLEMS AFFECTED BY SPA USE**

- Pregnant women should consult a physician before using spa.
- Persons suffering from obesity or with a medical history of heart disease, low or high blood pressure, circulatory system problems, or diabetes should consult a physician before using spa.

## **UNCLEAN WATER**

- Keep the water clean and sanitized with correct chemical care. The recommended levels for your **HOT SPOT** Spa are:  
Free Available Chlorine (FAC):      3.0-5.0 ppm                      Total Alkalinity:              40-120 ppm  
Water pH:                                      7.2-7.6                                      Calcium Hardness:              50-150 ppm

(Refer to Water Quality and Maintenance section for complete instructions.)

**Important:** Turn on the jet pump for a least ten minutes after adding ANY spa water chemicals into the filter compartment.

- Clean the filter cartridge monthly to remove debris and mineral buildup which may affect the performance of the hydromassage jets, limit the flow, or trip the high limit thermostat which will turn off the entire spa.

## **AVOIDING THE RISK OF HYPERTHERMIA**

Prolonged immersion in hot water can result in HYPERTHERMIA, a dangerous condition which occurs when the internal temperature of the body reaches a level above normal (98.6°F or 37°C). The symptoms of hyperthermia include unawareness of impending hazard, failure to perceive heat, failure to recognize the need to exit the spa, physical inability to exit the spa, fetal damage in pregnant women, and unconsciousness resulting in a danger of drowning.



## **⚠ WARNING:**

The use of alcohol, drugs, or medication can greatly increase the risk of fatal hyperthermia in hot tubs and spas.

## **TO REDUCE THE RISK OF INJURY:**

- The water in the spa should never exceed 104°F (40°C) . Water temperatures between 100°F (38°C) and 104°F (40°C ) are considered safe for a healthy adult. Extended use can cause hyperthermia. Lower water temperatures are recommended for extended use (exceeding ten minutes) and for young children.
- Pregnant or possibly pregnant women should limit spa water temperatures to 100°F (38°C). Failure to do so may result in permanent injury to your baby.
- Do not use spa immediately following strenuous exercise.

## **AVOIDING THE RISK OF SKIN BURNS:**

### **⚠ WARNING:**

- To reduce the risk of injury, before entering a spa the user should measure the water temperature since the tolerance of temperature-regulating devices may vary.
- Test the water with your hand before entering the spa to be sure it's comfortable.

## **SAFETY SIGN**

Each **HOT SPOT** spa is shipped with a SAFETY SIGN in the owner's package. The sign, which is required as a condition of Product Listing, should be permanently installed where it is visible to the users of the spa. To obtain additional SAFETY SIGNS, contact your **HOT SPOT** dealer.

## **IMPORTANT SPA INSTRUCTIONS**

The following contains important spa information, and we strongly encourage you to read and apply them.

### **DO:**

- Use and lock the cover when the spa is not in use, whether it is empty or full.
- Follow the Spa Care and Maintenance recommendations stated in this manual.
- Use only approved accessories and recommended spa chemicals and cleaners.

### **DON'T:**

- Leave the **HOT SPOT** spa exposed to the sun without water or the cover in place. Exposure to direct sunlight can cause solar distress of the shell material.
- Roll or slide the spa on its side. This will damage the siding.
- Lift or drag the vinyl cover by using the cover lock straps; always lift or carry the cover by using the handles.
- Attempt to open the electrical control box. There are no user serviceable parts inside. Opening of the control box by the spa owner will void the warranty. If you have an operational problem, carefully go through the steps outlined in the Troubleshooting section. If you are not able to resolve the problem, contact your authorized **HOT SPOT** spa dealer. Many problems can easily be diagnosed over the telephone by an authorized service technician.

## **SPA SHELL**

Your **HOT SPOT** spa has an acrylic shell. Stains and dirt generally will not adhere to your spa's surface. A soft rag should easily remove most dirt. Most household chemicals are harmful to your spa's shell (see below for detailed information on cleaning agents). Always rinse off any spa shell cleaning agent with fresh water.

### **IMPORTANT:**

1. The following products are the **ONLY** approved cleaning agents for your **HOT SPOT** spa shell: plain water, FRESHWATER Spa Shine, Brillianize® or Soft Scrub®. The use of alcohol or any other household cleaner other than those listed to clean the spa shell surface is **NOT** recommended. **DO NOT** use any cleaning products containing abrasives or solvents since they may damage the shell surface, specifically: Simple Green®, Windex® or Spa Mitt. **NEVER USE HARSH CHEMICALS!** Damage to the shell by use of harsh chemicals is not covered under the warranty. Always rinse off any spa shell cleaning agent with fresh water.
2. Iron and copper in the water can stain the spa shell if allowed to go unchecked. Ask your **HOT SPOT** dealer about a Stain and Scale Inhibitor to use if your spa has a high concentration of dissolved minerals. (Watkins recommends FRESHWATER Stain & Scale Defense.)
3. Keep all cleaners out of the reach of children and use care when applying.

## **SAVE THESE INSTRUCTIONS**

# INSTALLATION INSTRUCTIONS

## SITE PREPARATION

You probably have a spot picked out for your new spa, whether it's indoors or outdoors, on a patio or on a deck. Just make sure you check the following:

- Always put your spa on a structurally sound, level surface. A filled spa can weigh a great deal. Make certain that the location you choose can support the weight of your filled spa.
- Don't forget to level your spa before filling it (see Spa Leveling Preparation on next page).
- Locate your equipment compartment, which houses all of the electrical components, in a place where water will drain away from it. Allowing water into the equipment compartment can damage the electronics, or may result in tripping your home's circuit breaker.
- Leave yourself easy access to the Ground Fault Circuit Interrupter (GFCI) for testing. The GFCI is located at the end of the power cord, or at the subpanel of a hard-wired spa.
- Never let water get into the subpanel or into the electrical outlet that your spa is plugged into. Consult your local code authority to determine if an electrical outlet with a cover is required for your installation.
- Leave access to the equipment compartment for periodic spa care and maintenance.

**⚠ WARNING: DAMAGE TO THE SPA'S EQUIPMENT COMPARTMENT COMPONENTS OR INTERNAL PLUMBING AS A RESULT OF RODENT INFESTATION IS NOT COVERED UNDER YOUR WARRANTY!**

## OUTDOOR AND PATIO INSTALLATION

No matter where you install your new spa, it's important that you have a solid foundation to support it. Structural damage to the spa, resulting from incorrect installation or placement on an inadequate foundation, is not covered under the spa's limited warranty.

If you install the spa outdoors, we recommend a reinforced concrete pad at least four inches thick. The reinforcing rod or mesh in the pad should be attached to a bond wire.

## DECK INSTALLATION

To be certain your deck can support your spa, you must know the deck's maximum load capacity. Consult a qualified building contractor or structural engineer. To find the weight of your spa, its contents and occupants, refer to the Spa Specification pages of this manual. This weight per square foot must not exceed the structure's rated capacity, or serious structural damage could result.

## INDOOR/BASEMENT INSTALLATION

Be aware of some special requirements if you place your spa indoors. Water will accumulate around the spa, so flooring materials must provide a good grip when wet. Proper drainage is essential to prevent a build-up of water around the spa. When building a new room for the spa it is recommended that a floor drain be installed. The humidity will naturally increase with the spa installed indoors. Water may get into woodwork and produce dry rot, mildew, or other problems. Check for airborne moisture's effects on exposed wood, paper, etc. in the room. To minimize these effects, it is best to provide plenty of ventilation to the spa area. An architect can help to determine if more ventilation must be installed.

Your spa dealer can help you with local information such as zoning regulations and building codes.

**⚠ WARNING:** Please keep the area around your spa well ventilated when it is installed indoors or in a confined area. Inadequate ventilation around the spa could cause a build-up of a higher-than-normal concentration of spa chemicals and/or bacterial fragments. These dispersed spa chemicals and/or bacterial fragments can be inhaled, and may result in breathing difficulties or lung damage in certain people suffering from a compromised immune system or respiratory infection. If you or other bathers are affected by this condition, please seek medical attention as soon as possible.

In addition to the above, properly clean and maintain your spa as follows:

- Follow all procedures in this Owner's Manual and printed instructions on all water care (chemical) products packaging.
- Test the water regularly to ensure proper levels of sanitizers, pH, and other water care requirements.
- Drain, clean, and refill your spa with fresh water on a regular schedule, and in accordance with this owner's manual.
- Clean the filter(s) at least once per month.
- Check to make sure you have proper circulation throughout your spa water system.
- Have spa users bathe before entering the spa water.

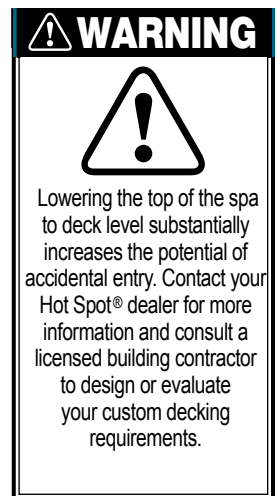

# SPA LEVELING PREPARATION

Concrete sloped at ½ inch (1.3 cm) per 10 feet (305 cm) is preferred so that rain water and water spillover will run off and not puddle underneath the spa (water under the spa for long periods of time may cause the wood to deteriorate). Other options are brick, stepping stone, or blocks.

It is important to note that soft surfaces, even when stepping stones are used to evenly distribute the weight of the spa, will have a tendency to settle, thus resulting in an unlevelled spa.

**NOTE:** Placing the spa on grass or dirt may increase the amount of debris which is inadvertently brought into the spa water and may cause harm to your equipment as well as the spa surface, which is not covered under warranty.

Spa models can not be shimmed. Make sure the pad where the spa will be placed onto is level as illustrated above. No other leveling is needed.

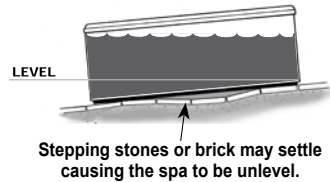
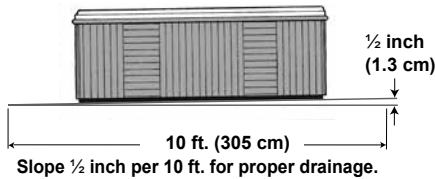

# SPA COVER INSTALLATION

- Place the cover squarely on the spa.
- Position the tie-down locks included with your cover on the side of the spa so that they are easily reached by the cover tie-down straps. Allow for about ½ inch (1.3cm) to ¾ inch (1.9cm) slack in the straps to make it easy to insert straps into locks and to compensate for vinyl shrinkage in cold weather.
- Attach the locks with the screws provided and insert the cover tie-down straps into the locks.

**NOTE:** Keeping the cover in place any time the spa is not in use will reduce the amount of time the heater operates, thereby minimizing operating costs

## DANGER. RISK OF INJURY.

- **Never leave a spa uncovered or unattended.**
- **Never leave a spa cover unlocked.**
- **Do not stand, sit, or lie on the cover.**

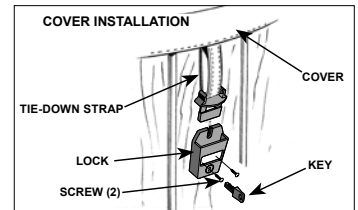

# ELECTRICAL INSTALLATION

## SELECTING THE VOLTAGE FOR YOUR SPA

The TX operates on 115 volts 15 amp and the SX operates on 115 volts 20 amp 60 Hz. Both the SX and TX can also be converted to either 115 volt 30 amp or 230 volt 50 amp. The **TEMPO**, **RELAY** and **RHYTHM** models require a dedicated 230 volt power supply. When the TX or SX spas are connected to 115 volts 15/20 amp, the heater will provide approximately 1000 watts of heat only when the pump is operating in LOW speed and the thermostat is calling for heat. When the TX, SX spas are connected to 115 volts 30 amp, the heater will provide approximately 1000 watts of heat when the pump is operating in LOW or HIGH speed and the thermostat is calling for heat. When the TX or SX are connected to 230 volts 50 amps, the heater will provide approximately 4000 watts of heat when the pump is operating in LOW or HIGH speed and the thermostat is calling for heat.

All electrical connections must be made in accordance with the wiring information contained in the electrical control box or on the back of the field wiring access panel of the equipment module.

## 115 VOLT INSTALLATION

Spas provided with a factory- installed power supply cord are to be plugged into a grounded, grounding type, 115 volt, 15 ampere receptacle (TX) or 20 ampere receptacle (SX model). No other electrical appliance or fixture can be used on this circuit.

**IMPORTANT:** Under **NO** circumstances should an extension cord be used. Use of an extension cord will seriously degrade the performance of the equipment module and can create an electrical hazard.

## 230 VOLT INSTALLATION

When using 230 volt power supply, installation of a 50 amp dedicated circuit is required. Your spa must be hard wired direct to a GFCI-protected subpanel by a licensed electrician. A wiring diagram is provided inside the equipment module showing where the connections are to be made.



# ELECTRICAL REQUIREMENTS AND PRECAUTIONS

Your **HOT SPOT** spa has been carefully designed to give you maximum safety against electrical shock. Connecting the spa to an improperly wired circuit will negate many of the spa's safety features. Improper wiring may also cause electrocution, risk of fire, and other risks of injuries. Please read and follow the electrical installation requirements and instructions for your spa completely!

## 115 VOLT 30 AMP CONVERSION (SX & TX)

### Conversion instructions

**NOTE:** An Authorized **HOT SPOT** Spa Technician must reconfigure spa using the soft jumpers to allow the heater to run concurrent with jet pump.

A licensed electrician must install the sub-panel (available from your **HOT SPOT** Spa Dealer) to supply power to the spa. The sub-panel must be placed in sight of the spa, at a minimum distance of 5 feet (1.5 m) away.

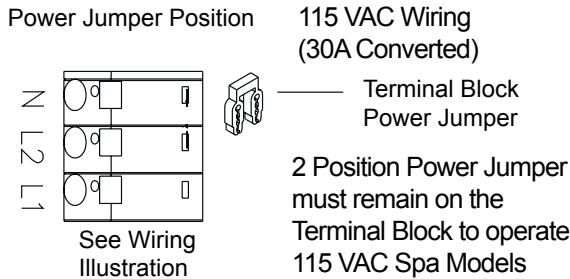

### 30 Amp sub-panel wiring instructions

**NOTE:** The sub-panel must be placed within 100 feet (30.5m) of the main electrical service panel, and between 5 and 50 feet (1.5 and 15 meters) away from the spa. Refer to the wiring diagram below.

1. Connect the #10 AWG, WHITE [NEUTRAL] wire from the main electrical service panel to the sub-panel NEUTRAL bar.
2. Connect the #10 AWG, GREEN [GROUND] wire from the main electrical service panel to the sub-panel GROUND bar.
3. Connect the #10 AWG, BLACK [L1] wire from the main electrical service panel to the sub-panel [terminal L1].
4. Check the connections internal to the sub-panel and be sure that a pigtail wire exists between the neutral bar and the 30 amp breaker. NEVER remove the pigtail wires!

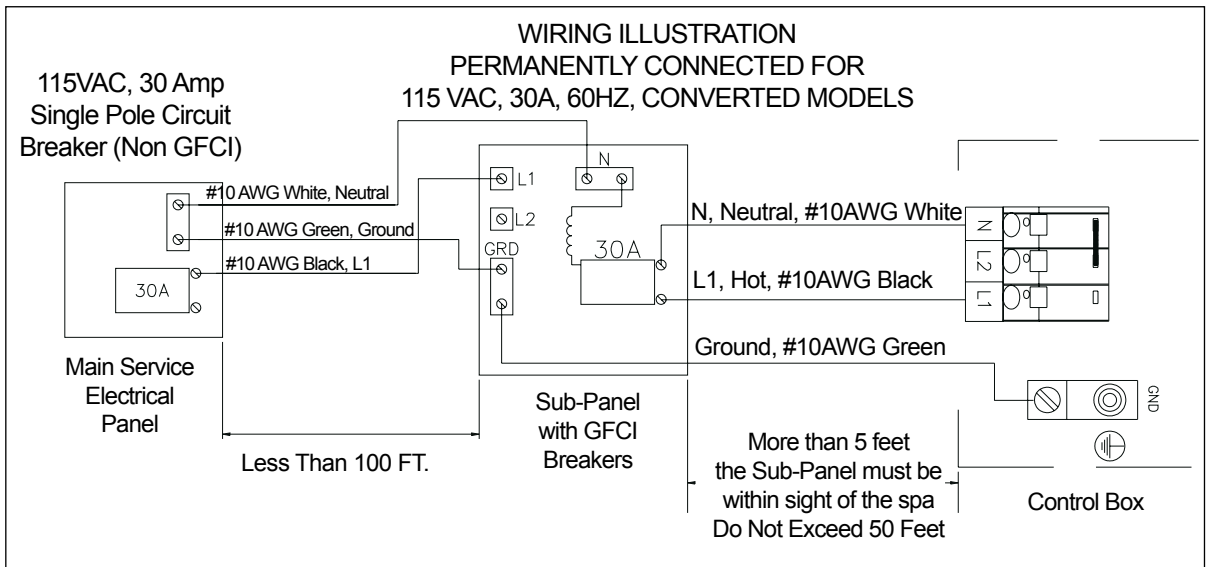

5. Inside the control panel, locate the terminal block (TB-1).
6. Remove existing power cord.
7. Connect the #10 AWG, BLACK wire from the sub-panel 30 amp GFCI breaker [terminal L1] to TB-1 terminal L1.
8. Connect the #10 AWG, WHITE wire from the sub-panel 30 amp GFCI breaker [terminal N, load neutral] to TB-1 terminal N.
9. Connect the #10 AWG, GREEN wire from the sub-panel GROUND bar to TB-1 terminal GROUND.

The GFCI breaker inside the sub-panel supplies all of the power to the spa. Before each use, open the sub-panel and press the TEST button located on the sub-panel GFCI breaker. The breaker should snap into the "tripped" position and the spa should stop operating. Reset the sub-panel GFCI breaker by completely pressing the breaker switch down, into the OFF position. Then, flip the breaker switch up, into the ON position. Power should be restored and the spa should resume operation.

If the GFCI breaker fails to operate in this manner, it is an indication of an electrical malfunction and the possibility of an electric shock. Disconnect the power until the fault has been identified and corrected.

**IMPORTANT:** Should you ever find the need to move or relocate your **HOT SPOT** spa, it is essential that you understand and apply these installation requirements. Your **HOT SPOT** spa has been carefully engineered to provide maximum safety against electric shock. Remember, connecting the spa to an improperly wired circuit will negate many of its safety features.

## 230 VOLT CONVERSION, 30 OR 50 AMP (SX & TX)

### Conversion instructions

**NOTE:** An Authorized **HOT SPOT** Spa Technician must reconfigure spa using the soft jumpers.

A licensed electrician must install the sub-panel (available from your **HOT SPOT** Spa Dealer) to supply power to the spa. The sub-panel must be placed in sight of the spa, at a minimum distance of 5 feet (1.5 m) away.

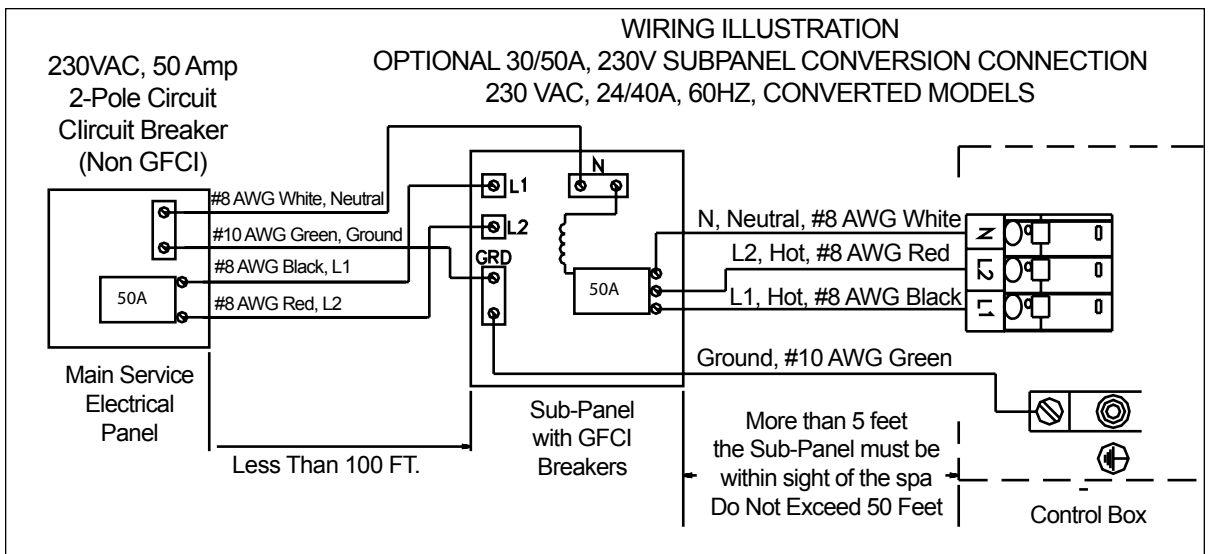

#### Power Jumper Position

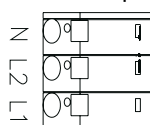

See Wiring  
 Illustration

230 VAC Wiring  
 (50A Converted)



2 Position Power Jumper  
 must be removed on the  
 Terminal Block to operate  
 230 VAC Spa Models

## 50 AMP SUB-PANEL WIRING INSTRUCTIONS (SX & TX MODELS)

**NOTE:** The sub-panel must be placed within 100 feet (30.5m) of the main electrical service panel, and between 5 and 50 feet (1.5 and 15 meters) away from the spa. Refer to the wiring diagram above.

1. Connect the #8 AWG, WHITE [NEUTRAL] wire from the main electrical service panel to the sub-panel NEUTRAL bar.
2. Connect the #10 AWG, GREEN [GROUND] wire from the main electrical service panel to the sub-panel GROUND bar.
3. Connect the #8 AWG, BLACK [L1] wire from the main electrical service panel to the sub-panel [terminal L1].
4. Connect the #8 AWG, RED [L2] wire from the main electrical service panel to the sub-panel [terminal L2].
5. Check the connections internal to the sub-panel and be sure that a pigtail wire exists between the neutral bar and the 50 amp breaker. NEVER remove the pigtail wires!
6. Inside the control panel, locate the terminal block (TB-1).
7. Remove existing power cord.
8. Connect the #8 AWG, BLACK wire from the sub-panel 50 amp GFCI breaker [terminal L1] to TB-1 terminal L1.
9. Connect the #8 AWG, RED wire from the sub-panel 50 amp GFCI breaker [terminal L2] to TB-1 terminal L2.
10. Connect the #8 AWG, WHITE wire from the sub-panel 50 amp GFCI breaker [terminal N, load neutral] to TB-1 terminal N.
11. Connect the #10 AWG, GREEN wire from the sub-panel GROUND bar to TB-1 terminal GROUND.

The GFCI breaker inside the sub-panel supplies all of the power to the spa. Before each use, open the sub-panel and press the TEST button located on the sub-panel GFCI breaker. The breaker should snap into the "tripped" position and the spa should stop operating. Reset the sub-panel GFCI breaker by completely pressing the breaker switch down, into the off position. Then, flip the breaker switch up, into the on position. Power should be restored and the spa should resume operation.

If the GFCI breaker fails to operate in this manner, it is an indication of an electrical malfunction and the possibility of an electric shock. Disconnect the power until the fault has been identified and corrected.

**IMPORTANT:** Should you ever find the need to move or relocate your **HOT SPOT** spa, it is essential that you understand and apply these installation requirements. Your spa has been carefully engineered to provide maximum safety against electric shock. Remember, connecting the spa to an improperly wired circuit will negate many of its safety features.

# 230 VOLT SUBPANEL WIRING INSTRUCTIONS (TEMPO, RELAY & RHYTHM)

**NOTE:** The subpanel must be placed within 100 feet (30.5m) of the main electrical service panel, and between 5 (1.5 m) and 50 feet (15 m) away from the spa. All electrical connections must be made in accordance with the wiring information contained in this manual and on the back of the field wiring access panel of the control box.

Refer to the wiring diagram below.

1. Connect the #8 AWG, WHITE [NEUTRAL] wire from the Neutral/Ground Bar on the main electrical service to the WHITE [NEUTRAL, Panel Neutral, Pigtail] of the subpanel.
2. Connect the #8 AWG, BLACK [L1] wire from the main electrical service to the subpanel [terminal L1].
3. Connect the #8 AWG, RED [L2] wire from the main electrical service to the subpanel [terminal L2].
4. Connect the #10 AWG, GREEN wire from the Neutral/Ground Bar on the main electrical service to the GROUND terminal of the subpanel.
5. Connect the #8 AWG, WHITE [NEUTRAL] wire from the subpanel breaker to the Neutral terminal on the spa's control box.
6. Connect the #8 AWG, BLACK [L1] wire from the subpanel breaker to terminal [L1] on the spa's control box.
7. Connect the #8 AWG, RED [L2] wire from the subpanel breaker to terminal [L2] on the spa's control box.
8. Connect the #10 AWG, GREEN wire from the GROUND terminal of the subpanel to the GROUND terminal in the spa's control box.
9. Bond the spa to all exposed metal equipment or fixtures, handrails, and concrete pad per N.E.C. and all local codes.

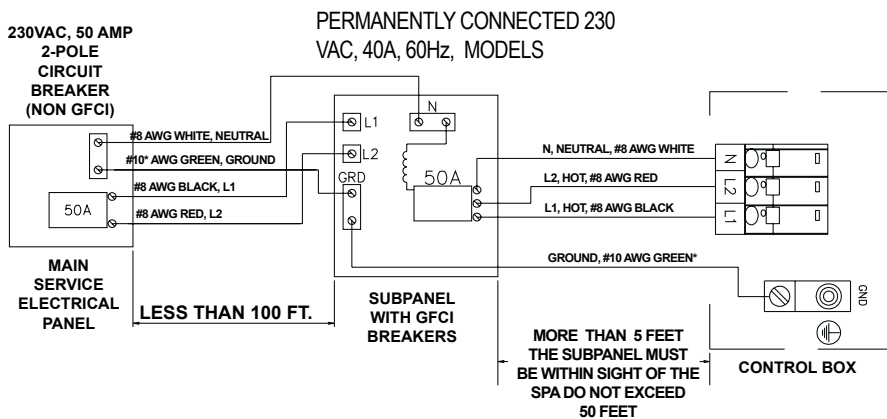

\*ALL CANADIAN SPA MODELS USE #8 AWG GREEN, GROUND.  
THESE SPAS ARE INTENDED FOR USE WITH GFCI SUBPANEL PROVIDED.

# SPA SPECIFICATIONS & ILLUSTRATION

## TEMPO (MODEL TEM)

HORIZONTAL DIMENSIONS:	89" (226 cm.) square
HEIGHT (without cover):	39" (99 cm.)
EFFECTIVE FILTER AREA:	.65 sq. ft. (6.0 m <sup>2</sup> )
HEATER:	4000 watts (4.0 kW)
WATER (capacity):	400 gallons (1514 liters)
WEIGHT:	911 lbs. dry (413 kg.), 5297 lbs. filled (2403 kg.) (Includes weight of water and 6 adults @ 175 lbs./79kg. each)
DEAD WEIGHT (filled):	120 lbs. per sq. ft., 586 kg. per m <sup>2</sup>
ELECTRICAL REQUIREMENTS:	230 volt 50 amp single phase G.F.C.I. circuit
NOTE:	All wiring must be performed by a licensed electrician
CERTIFICATIONS:	ETL Listed

### OVERHEAD VIEW

- A. Air Control Lever
- B. Control Panel
- C. Filter Compartment Cover\*
- D. Temperature Sensor
- E. Directional Precision® Jet
- F. Directional Hydromassage Jet
- G. Rotary Hydromassage
- H. Outlet for Optional Ozone
- I. Drain/Suction
- J. Pillow
- K. Waterfall
- L. Waterfall On/Off Valve

**\* WARNING: DO NOT SIT IN THE FILTER COMPARTMENT AREA  
"THIS IS NOT A SEAT"!!!**

Sitting in this area can cause:

- Restriction of filter pump suction/vacuum.
- Damage to components.

Both can result in bodily harm.

Should damage occur to components in this area, replace immediately!





# RELAY (MODEL REL)

HORIZONTAL DIMENSIONS: ..... 84" (213 cm.) square  
 HEIGHT (without cover): ..... 36.75" (93 cm.)  
 EFFECTIVE FILTER AREA: ..... .65 sq. ft. (6.0 m<sup>2</sup>)  
 HEATER: ..... 4000 watts (4.0 kW)  
 WATER (capacity): ..... 360 gallons (1363 liters)  
 WEIGHT: ..... 836 lbs. dry (379 kg.), 4888 lbs. filled (2217 kg.)  
 (Includes weight of water and 6 adults @ 175 lbs./79kg. each)  
 DEAD WEIGHT (filled): ..... 120 lbs. per sq. ft., 586 kg. per m<sup>2</sup>  
 ELECTRICAL REQUIREMENTS: ..... 230 volt 50 amp single phase G.F.C.I. circuit  
 NOTE: ..... All wiring must be performed by a licensed electrician  
 CERTIFICATIONS: ..... ETL Listed

## OVERHEAD VIEW

- A. Air Control Lever
- B. Control Panel
- C. Filter Compartment Cover\*
- D. Temperature Sensor
- E. Directional **PRECISION** Jets
- F. Directional Hydromassage Jet
- G. Rotary Hydromassage Jet
- H. Outlet for Optional Ozone
- I. Drain/Suction
- J. Pillow
- K. Waterfall
- L. Waterfall On/Off Valve

**\* WARNING: DO NOT SIT IN THE FILTER COMPARTMENT AREA  
 "THIS IS NOT A SEAT"!!!**

Sitting in this area can cause:

- Restriction of filter pump suction/vacuum.
- Damage to components.

Both can result in bodily harm.

Should damage occur to components in this area, replace immediately!



# RHYTHM (MODEL RHY)

HORIZONTAL DIMENSIONS: ..... 84" (213 cm.) square  
 HEIGHT (without cover): ..... 36.75" (93 cm.)  
 EFFECTIVE FILTER AREA: ..... .65 sq. ft. (6.0 m<sup>2</sup>)  
 HEATER: ..... 4000 watts (4.0 kW)  
 WATER (capacity): ..... 375 gallons (1420 liters)  
 WEIGHT: ..... 847 lbs. dry (384 kg.), 5200 lbs. filled (2358 kg.)  
 (Includes weight of water and 7 adults @ 175 lbs./79kg. each)  
 DEAD WEIGHT (filled): ..... 125 lbs. per sq. ft., 610 kg. per m<sup>2</sup>  
 ELECTRICAL REQUIREMENTS: ..... 230 volt 50 amp single phase G.F.C.I. circuit  
 NOTE: ..... All wiring must be performed by a licensed electrician  
 CERTIFICATIONS: ..... ETL Listed

## OVERHEAD VIEW

- A. Air Control Lever
- B. Control Panel
- C. Filter Compartment Cover\*
- D. Temperature Sensor
- E. Directional **PRECISION** Jets
- F. Directional Hydromassage Jet
- G. Rotary Hydromassage Jet
- H. Outlet for Optional Ozone
- I. Drain/Suction
- J. Pillow
- K. Waterfall
- L. Waterfall On/Off Valve

**\* WARNING: DO NOT SIT IN THE FILTER COMPARTMENT AREA**  
**"THIS IS NOT A SEAT"!!!**

Sitting in this area can cause:

- Restriction of filter pump suction/vacuum.
- Damage to components.

Both can result in bodily harm.

Should damage occur to components in this area, replace immediately!



# SX (MODEL SX)

HORIZONTAL DIMENSIONS:	72" (183cm.) square
HEIGHT (without cover):	33" (83.8 cm.)
EFFECTIVE FILTER AREA:	.30 sq. ft. (2.79 m <sup>2</sup> )
HEATER:	1000 watts (1.0 kW), 4000 watts (4.0 kW) @ 230 volts
WATER (capacity):	285 gallons (1078 liters)
WEIGHT:	718 lbs. dry (326 kg.), 3620 lbs. filled (1642 kg.) (Includes weight of water and 3 adults @ 175/lbs/79kg. each)
DEAD WEIGHT (filled):	130 lbs. per sq. ft., 635 kg. per m <sup>2</sup>
ELECTRICAL REQUIREMENTS:	115 volt 20 amp grounded circuit 115 volt 30 amp grounded circuit (optional) - requires 30 amp subpanel 230 volt 50 amp single phase G.F.C.I. circuit (optional) - requires 50 amp subpanel
NOTE:	30/50 amp wiring must be performed by a licensed electrician.
CERTIFICATIONS:	ETL Listed

## OVERHEAD VIEW

- A. Control Panel
- B. Spa Light
- C. Filter Lid
- D. Pillow
- E. Directional **PRECISION** Jet
- F. Moto-Massage<sup>®</sup> Jet
- G. Air Control lever
- H. Suction
- I. Floor Drain



# TX (MODEL TX)

HORIZONTAL DIMENSIONS:	68.5" x 68.5" (174 cm x 174 cm)
HEIGHT (without cover):	29" (74 cm.)
EFFECTIVE FILTER AREA:	30 sq. ft. (2.7 m <sup>2</sup> )
HEATER:	1000 watts (1.0 kW) @ 115V 15 amp, 4000 watts (4.0 kW) @ 230 volts
WATER (capacity):	140 gallons (530 liters)
WEIGHT:	526 lbs. dry (239 kg.), 2044 lbs. filled (927 kg.) (Includes weight of water and 2 adults @ 175lbs./79kg. each)
DEAD WEIGHT (filled):	100 lbs. per sq. ft., 488 kg. per m <sup>2</sup>
ELECTRICAL REQUIREMENTS:	115 volt 15 amp grounded circuit 115 volt 30 amp grounded circuit (optional) - requires 30 amp subpanel 230 volt 50 amp single phase G.F.C.I. circuit (optional) - requires 50 amp subpanel
NOTE:	30/50 amp wiring must be performed by a licensed electrician.
CERTIFICATIONS:	ETL Listed

## OVERHEAD VIEW

- A. Control Panel
- B. Spa Light
- C. Filter Lid
- D. Pillow
- E. Directional **PRECISION** Jet
- F. Rotary Hydromassage Jet
- G. **MOTO-MASSAGE** Jet
- H. Air Control Lever
- I. Floor Drain
- J. Suction



# OPERATING INSTRUCTIONS

## START-UP AND REFILL PROCEDURES

Your **HOT SPOT** spa has been thoroughly tested during the manufacturing process to ensure reliability and long-term customer satisfaction. A small amount of water may have remained in the plumbing after testing and, as a result, may have spotted the spa shell or the spa siding prior to delivery. Before filling the spa, wipe the spa shell clean with a soft rag.

The following instructions must be read and followed exactly to ensure a successful start-up or refill.

### CAUTIONS

- Do not fill the spa with hot water, as tripping of the high-limit thermostat may result.
  - **DO NOT CONNECT POWER TO AN EMPTY SPA.** Power to the spa automatically activates critical components within the spa, such as controls, heater, and other systems. If power is supplied to these components prior to the spa being filled, the components will be damaged, and this may result in a non-warranty component failure.
  - Do not leave spa uncovered when filling. Solar distress can damage shell.
  - Do not use your spa after filling until all of the steps listed below are completed.
  - Do not add chlorine if treating your spa with polyhexamethylene biguanide (Biguanide, PHMB, eg. BaquaSpa®) sanitizer.
  - Before filling your spa for the first time, remove the equipment compartment door and check to ensure that the unions on either side of the pump(s) and heater are hand-tight.
1. Ensure the drain is closed. Insert the end of a garden hose into the filter compartment and begin filling the spa. The water level of your **HOT SPOT** spa should be maintained at a level one inch above the highest jet in the spa.  
**RECOMMENDED:** Use the Clean Screen™ pre-filter to remove unwanted contaminants from the tap water.  
**IMPORTANT:** Watkins Manufacturing Corporation does not recommend that the spa be filled with “softened” water, as this may damage the spa’s equipment.
  2. **AFTER** the spa has been filled with water and the equipment compartment door is secured, power must be applied to the spa.
    - **Cord connected models:** Connect the GFCI to the waterproof receptacle and push the RESET button on the GFCI.
    - **Hard wired models:** Open the door of the electrical subpanel and reset the GFCI breaker. Close and secure the subpanel door.
  3. The jet pump(s), heating system and all internal plumbing will achieve a partial prime as the spa is filled. To check the operation of the jet system and to purge any remaining air from the heating system, push the JETS button on the control pad twice (three times for **TEMPO & RELAY**) to make the jet pump(s) run on high speed for one minute. Once the jet system is fully operational (as indicated by strong, non-surgingly jets), priming of the spa is complete. If you do not feel a steady stream of water from your jets, refer to the instructions for priming the pump in the SPA TROUBLESHOOTING section in the back of this manual.
  4. Adjust Total Alkalinity (TA) to 40-120 ppm, Calcium Hardness (CH) to 50-150 ppm, then spa water pH to between 7.2 and 7.6. These procedures are listed in the “Water Quality and Maintenance” section.  
**IMPORTANT:** Add spa water chemicals directly into the filter compartment after activating “Clean Cycle”.  
**OPERATION NOTE:** Adjusting the Total Alkalinity as the first step is important, as out-of-balance TA will affect your ability to adjust the pH correctly and will prevent the sanitizer from operating effectively.
  5. Superchlorinate the spa water by adding 1½ teaspoons of chlorine (sodium dichlor) per 250 gallons (950 liters) of spa water into the filter compartment after activating “Clean Cycle” the jets will remain on high to circulate the spa water for a ten-minute period.
  6. The spa temperature is pre-programmed to reach 100°F (38°C), and will normally do so within 18 to 24 hours. Set the temperature control to the desired temperature between 100°F (38°C) and 104°F (40°C), then place the cover on the spa and allow the water temperature to stabilize. Make sure you secure the cover in place using the cover locks. Periodically check the spa water temperature. When the water temperature climbs above 90°F (32°C), proceed to the next step.
  7. Activate “Clean Cycle” to run the jets for 10 minutes to circulate the spa water. After the clean cycle is complete, test the spa water for Free Available Chlorine (FAC) residual. If the residual is between 3 and 5 ppm on the test strips (found in most chemical test kits) go on to the next step. If the residual is less than 3 ppm, superchlorinate the spa water by adding 1½ teaspoons of chlorine (sodium dichlor) per 250 gallons (950 liters) of spa water, while running the clean cycle.
  8. Recheck the Total Alkalinity (TA) to 40-120 ppm, Calcium Hardness (CH) to 50-150 ppm, then spa water pH at between 7.2 and 7.6.  
**OPERATION NOTE:** Make sure you adjust you Total Alkalinity first, as an out-of-balance condition will affect your ability to adjust the pH correctly, and will prevent the sanitizer from operating effectively. **The spa is ready for use when the spa water has circulated and the chlorine level remains between 3 ppm and 5 ppm.**



## OPERATION NOTES:

1. Your spa is equipped with a ten-minute timer delay on the heating/maintenance mode. Whenever the jet pump has been turned off (a demand for heat has occurred) or the temperature control has been turned up, it will take ten minutes before the low speed of the jet pump and heater become activated. Always push the JETS button to turn off the jet pump when exiting the spa. In the standard 115 volt, 15 amp electrical configuration, the heating system does not operate simultaneously with the high speed pump. On the 230-volt system, the heating system does operate simultaneously with the high speed pump.
2. The spa controller has an automatic two hour "time-out" feature should the high speed jet mode be left on inadvertently. **After one hour of continuous operation, the controller will automatically return to the maintenance/heating mode.**
3. The spa controller also has a six-hour "time-out" feature should the light be left on inadvertently. **After six hours of continuous operation, the controller will automatically turn the light off.**

## HEATING AND HYDROMASSAGE SYSTEMS

The **HOT SPOT** spas use two-speed jet pumps to operate hydromassage jets and to circulate the spa water through the heating system (the **TEMPO**, **RELAY** and **RHYTHM** are also equipped with a single speed jet pump used for jets only). The low speed mode of the pump, which is activated automatically by the control thermostat, will cause the spa water to be drawn slowly in through the filter, the heater, and into the pump. The pump, in turn, will push the water back into the spa through the jets. When the JETS button is pushed one time, the spa user can activate the low speed of the jet pump. (The heater may or may not be on, depending on whether the control thermostat has indicated a demand for heat.) When the **JETS** button is pushed a second time, the high speed of the jet pump will be activated. (This will automatically deactivate the heater if it is operating in a standard 115 volt 15 or 20 amp system.)

In the 230 volt electrical system, if a drop in the water temperature has occurred, the spa heater will operate simultaneously when the jet pump is operating on high speed. In a standard 115 volt 15 or 20 amp electrical system, the spa heater will not operate simultaneously when the jet pump is operating on high speed, even if a drop in the water temperature has occurred. In either electrical configuration, when the high speed mode of the jet pump is turned off, the spa will enter a ten-minute "tranquil mode." During this time the heating system (and simultaneous operation of the jet pump at low speed) will not operate (unless the JETS button is pushed), even if the water temperature has dropped below the control setting. Once the ten-minute period has expired, the spa controller will switch to the maintenance mode and the heating system will be automatically activated.

The **HOT SPOT** spas are equipped with a state-of-the-art heating system. The system uses an exclusive "flow through" No-Fault® stainless steel heater.

## HYDROMASSAGE JETS

The larger jets in your spa allow you to re-direct the jet stream by changing the position of the nozzle.

Regulate the force of the massage by rotating the jet face clockwise to reduce the force or counter-clockwise to increase the force. Notice that turning off the flow to some jets increases the flow to the other jets. To avoid damage to your spa's plumbing and components, **do not turn off more than half of these jets at the same time.**

## PRECISION JETS

**PRECISION** jets are small. They are designed to perform a soft, soothing massage on your feet, calf, back and shoulders. The Air Control levers are used to change the air intensity of a group of **PRECISION** jets simultaneously.

## AIR CONTROL SYSTEM

**AIR CONTROL VALVE:** Turning the air control lever to the left position allows for the same volume of air to flow to all individual jets and **PRECISION** jets simultaneously. The jet faceplate on the larger jets is then used to control the water intensity of each hydromassage jet.

**NOTE:** Always turn the air control lever to the right position anytime the spa is not being used. This will help make the spa operate more quietly and heat more efficiently when the vinyl cover is in place.

## WATERFALL VALVE (TEMPO, RELAY & RHYTHM MODELS ONLY)

The **TEMPO**, **RELAY** & **RHYTHM** spas are equipped with a cascading water feature. It is activated by pressing the JETS button up to 3 times when the jets are off and turning the waterfall valve clockwise. The flow is regulated by turning the valve to the desired position.

When not in use turn the on/off valve to the OFF position.

## MOTO-MASSAGE JET (SX & TX MODELS ONLY)

The **MOTO-MASSAGE** jet automatically travels up and down in a sweeping motion, simulating the natural stroking effects of a manual massage. The intensity and speed of the **MOTO-MASSAGE** jet may be adjusted by turning the Air Control lever.

# SAFETY EQUIPMENT

- A. GFCI: The Ground Fault Circuit Interrupter, located on the end of the power cord (115 Volt models only), is a safety device that is designed to sense as little as 5 milliamps of electrical current leakage to ground. It is very important to protect a GFCI from rain and other moisture. Watkins Manufacturing Corporation recommends that the GFCI be tested before each use to ensure it is functioning correctly.

## TO TEST THE GFCI:

**Cord-Connected models:** Before each use, with the spa operating, push the TEST button (located on the front of the GFCI). The GFCI breaker should trip to the "off" position, disconnecting power to the spa. Reset the GFCI by pushing the RESET button. The spa will now operate normally. If the interrupter does not perform in this manner, it is an indication of an electrical malfunction and the possibility of an electric shock. Unplug the spa until the fault has been identified and corrected.

**Hard Wired models:** The GFCI breaker is located inside the subpanel, before each use of the spa and with the unit operating, push the Test button on each breaker. The switch should click over to the "Trip" position. Wait 30 seconds and reset each GFCI breaker by switching it completely off and then completely on. The switch should then stay on.

- B. **HEATER HIGH-LIMIT SWITCH:** The heater high-limit sensor is located on the heater assembly. If for any reason the internal temperature of the heater exceeds 119°F (48°C), the high-limit circuit will trip and turn off the spa. The control panel display will display - - - - and the READY icon will flash for the all spa models. The heater high-limit may be reset when the water temperature within the heater has cooled to approximately 110°F (43°C). Reset the heater high-limit by simply disconnecting power to the spa for thirty seconds. The cause of the overheating must be located to prevent a recurrence. The most common cause of limit-tripping is inadequate water flow through the heating system. This may be caused by an obstruction within the pump water lines (filter, pump intakes or internal plumbing), the non-function of the low-speed mode of the jet pump, or the malfunction of the control thermostat. Once the cause has been identified and corrected, and the sensor has cooled, reset spa by simply disconnecting power to the spa for thirty seconds.
- C. **PRESSURE SWITCH:** The pressure switch is located inside the control box on the heater, and is designed to prevent heater operation during a no or low flow condition. If for any reason flow through the heater is reduced or stopped, the pressure switch will trip. If the pressure switch has detected a no or low flow condition ===== will display for all spa models. The most common causes of inadequate heater flow are a dirty or clogged filter, obstruction in the plumbing lines, and non-operation of the low speed heat pump. Additionally, the control panel will display ===== for all spa models if the pressure switch senses flow through the heater when the jet pump is not activated. Contact your Authorized Service Technician if displayed.
- D. **CONTROL THERMOSTAT:** The control thermostat helps regulate the temperature of the water. If for any reason something were to happen to this device, the READY icon on the control panel will flash for the **TEMPO, RELAY, RHYTHM, SX & TX** spa models. Contact your Authorized Service Technician.

## SPA CONTROL PANEL - TEMPO, RELAY & RHYTHM ONLY

Your control panel consists of an LCD display and convenient touch pads that allow you to set the water temperature and adjust the skim/filter cycle settings, lock spa temp, lock all spa functions, as well as control the hydrotherapy jets, and lights.

### LCD DISPLAY INVERSION

You may invert the control panel display for easier viewing from inside the spa. To invert the display the following is required: Press the MODE(▼) and (+) buttons simultaneously. By pressing the MODE(▼) and (-) buttons simultaneously a second time the screen will go back to it's original display.

### MODE BUTTON

From the Home screen use the **MODE** (▲ or ▼) button to scroll to the System, Clean, Audio (if your spa is equipped) and Tools screen. Press the (+) button to enter into the sub screens.

### TEMPERATURE CONTROL

The set temperature range is from 80°F (26°C) to 104°F (40°C). Temperatures of any setting may rise slightly depending on the current use and condition of your spa, and on outside temperature. Whenever power is disconnected and then reconnected to the spa, the water temperature setting will automatically return to the last temperature entered into the program.

To increase the set temperature, press the (+) button, once for each degree of increase temperature desired. If you hold the (+) button down, the set temperature will increase by one degree every half second.

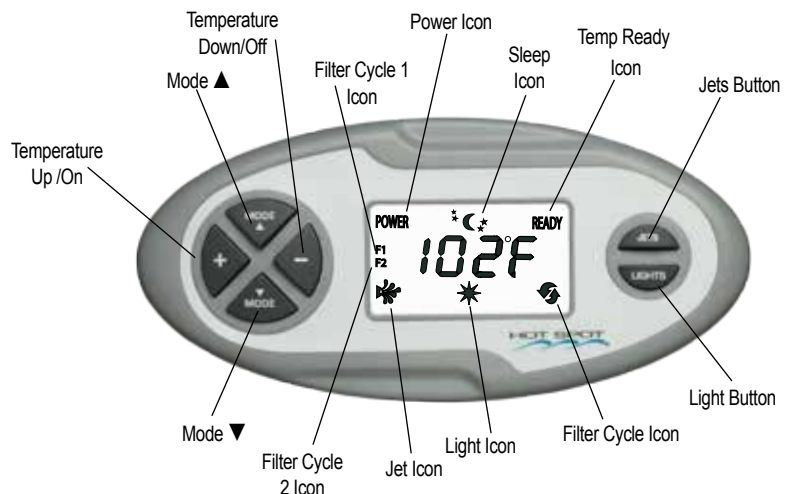

To decrease the set temperature, press the (-) button, once for each degree of decreased temperature desired. If you hold the (-) button down, the set temperature will decrease by one degree every half second.

## JET PUMP CONTROL

Pressing the JET button for the TEMPO, RELAY & RHYTHM changes the jet pump functions, depending on the number of presses:

- 1st press: Two-speed jet pump runs on low speed
- 2nd press: Two-speed jet pump runs on high speed
- 3rd press: One and Two-speed jet pumps run on high speed
- 4th press: One-speed jet pump runs on high speed
- 5th press: Both jet pumps are off



## LIGHT - ON/OFF & INTENSITY CONTROLS

The light control uses four positions: High, Medium, Low, and Off. To turn on the spa light, press the LIGHT button. This will place all lights in the High, or maximum intensity position. When the lights turn on, the light symbol will also illuminate on the control panel display. Press the LIGHT button again to lower the intensity of the lights to the Medium position. Press the LIGHT button again to lower the intensity even more, placing the lights intensity in the Low position. Press the LIGHT button one more time to shut the lights off. When the lights are deactivated, the light symbol will also turn off.

If the lights are left on, they will automatically be turned off by the control system after 6 hours of continuous operation. The light symbol on the panel will also turn off when the lights are deactivated.

If the lights will not turn on, make sure SPA LOCK is deactivated. SPA LOCK disables all the controls on the control panel (see following pages for more information on SPA LOCK).

## SYSTEM MODE

Your spa is equipped with a System Mode. This function will allow you to conveniently turn the jet(s) on high speed and the lights on maximum intensity at the same time.

To activate the System Mode, perform the following functions:

Press the MODE (▲ or ▼) button until SYSON is displayed on the screen. Press the (+) button to activate the SYSON mode feature. The jets and light icons will remain illuminated on the display until the system mode is deactivated.

**NOTE:** Once activated, the jet and light functions can still be changed by pressing the JETS or LIGHT button.

To deactivate the System Mode, press the MODE (▲ or ▼) button until the SYSON symbol is displayed on the screen. Press the (-) button to deactivate.

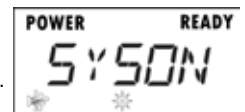

## CLEANING MODE

All spas are equipped with a "Cleaning" mode. When the mode is activated, the jet pump in the first jet system will turn on and run for ten minutes (used for water maintenance). To activate the "Cleaning" mode, press the MODE (▲ or ▼) button several times until the CLEAN menu is displayed. Press the (+) button to activate the CLEAN mode feature.

**NOTE:** The jet icon will flash on and off while the "Cleaning" mode is active.

To stop the Cleaning Cycle before the ten minutes is complete, Press the MODE (▲ or ▼) button several times until the CLEAN menu is displayed on the screen then press the (-) button to deactivate.

**NOTE:** Pressing the JETS button will also deactivate the clean cycle and the jet icon will remain on and solid



## TOOLS MENU

The TOOLS menu is one of the main menus on the control panel. Within the TOOLS menu are seven submenus, which consists of; Temp Lock, Spa Lock, Light, Econ or Summer Timer, Filter 1, Filter 2, LCD and Exit.

To enter onto the TOOLS menu, scroll through the main menus using the MODE (▲ or ▼) button until TOOLS is displayed. Press the (+) button to enter into the TOOLS submenu, use the MODE (▲ or ▼) button to scroll through the submenus. Once the desired submenu is displayed, press the (+) button to activate that submenu. To leave the TOOLS submenu, scroll through the submenu using the MODE (▲ or ▼) button until EXIT is displayed, then press the (+) button to exit the submenu.

## LOCKING FEATURES

The two locking features, SPA LOCK and TEMPERATURE LOCK, are enabled from the control panel by pressing the MODE (▲ or ▼) button until TOOLS is displayed. Then press the (+) button to enter the TOOLS submenus. Use the MODE (▲ or ▼) button to scroll through the submenus to get to the locking features. Once enabled, a lock will remain active until the specific button combination is applied to disable the lock. Even if power is disconnected from the spa and soon thereafter reapplied (such as in a power outage) the lock will remain in place.

## TEMPERATURE LOCK



The TEMPERATURE LOCK feature deactivates the temperature control function of the control panel. TEMPERATURE LOCK is most often used by people who do not want others to tamper with or change the set temperature of the spa water. TEMPERATURE LOCK is a submenu of the TOOLS menu

To activate the TEMPERATURE LOCK, press the MODE (▲ or ▼) button in the TOOLS submenu until the TLOK- symbol is displayed on the screen. Press the (+) button to activate the TEMPERATURE LOCK feature (TLOK+).

When the TEMPERATURE LOCK is activated, the JETS, LIGHTS and any other features your spa may have will operate normally, and the temperature setting can be viewed but can NOT be changed. If a temperature button is pressed, TLOK will display for several seconds, then turns off.

To deactivate the TEMPERATURE LOCK, press the MODE (▲ or ▼) button in the TOOLS submenu until the TLOK+ symbol is displayed on the screen. Press the (-) button to deactivate the TEMPERATURE LOCK feature.

## SPA LOCK

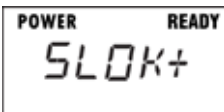

The SPA LOCK feature deactivates all of the functions of the control panel. It is generally used to prevent unwanted use of the spa. The SPA LOCK menu is a submenu of the TOOLS menu.

To activate the SPA LOCK, press the MODE (▲ or ▼) button in the TOOLS submenu until SLOK- is displayed on the screen. Press the (+) button to activate the SPA LOCK feature.

When the SPA LOCK is activated, the buttons for the jets, temperature control, light, and any other features your spa may have are deactivated. If Jets, Light button, or (+) or (-) button is pressed, the SLOK will display for several seconds, then turns off.

To deactivate the SPA LOCK, press the MODE (▲ or ▼) button in the TOOLS submenu until the SLOK+ symbol is displayed on the screen. Press the (-) button to deactivate the SPA LOCK feature.

## LOCK OVERRIDE

The Lock Override feature is for spa users who normally keep the set temperature locked. Should the user wish to lock all spa controls temporarily, the spa lock can be applied over an already-applied temperature lock. Then, when the spa lock is removed, the temperature lock will remain on to prevent unwanted tampering with the set temperature.

## LIGHT - MULTI-COLOR MENU CONTROLS (TEMPO, RELAY & RHYTHM ONLY)

Your spa lights can display a variety of different colors as well as run through a continuous sequence of colors (loop) at different speeds. To activate this function the following is required:

Press the MODE (▲ or ▼) button to scroll to the TOOLS screen. Once displayed, press the (+) button to enter the TOOLS submenu. Press the MODE (▲ or ▼) button to scroll to LIGHT screen, press the (+) button to enter DIM, screen. Press the (+) button or (-) button in the DIM screen to adjust the brightness of the lights. Press the MODE (▲) button to scroll to Color screen. Press the (+) button or (-) button in the COLOR screen as many times as desired to toggle through the different light colors. Press the MODE (▲) button to scroll to Loop screen. Press the (+) button or (-) button in the LOOP screen to select a continuous sequence of colors, the higher the loop number the faster the color sequence will run. Press the MODE (▲) button to scroll to EXIT screen. Press the (+) button in the EXIT screen to exit the LIGHT menu.

If the light is turned off while in the LOOP or COLOR mode, the same mode will exist when the light is reactivated. You will see a flashing light icon whenever your LOOP mode and light are turned on.

## SLEEP MODE

The Sleep Mode operation is a feature that minimizes pump operation during quiet evening hours. For example, if Filter Cycle 1 (F1) is set to activate at 8:00 a.m., by default, Filter Cycle 2 (F2) will activate at 8:00 p.m. (12 hours later). During 8:00 p.m. to 8:00 a.m., if the spa should call for heat, the pump and heater will activate to heat the spa under normal temperature demand. However, when in Sleep Mode, should the spa call for heat, the pump and heater will be suspended after Filter Cycle 2 (F2) until the activation of Filter Cycle 1 (F1), at 8:00 a.m. to minimize pump activation during quiet evening hours.

**Important:** Power-up of the spa starts the F1 sequence. In order for the sleep mode to work in the evening hours, the spa must be powered up in the early morning hours. The Sleep Mode will always be active the 6-12 hours between the end of (F2) and the beginning of (F1) depending on how the filter cycle program is set.

**Note:** If temperature drops below 80° F (27° C), heater will automatically activate to prevent spa from freezing.

To activate Sleep Mode feature:

- Press the MODE (▲ or ▼) button until the TOOLS screen is displayed.
- Press the (+) button to enter the TOOLS submenus.
- Press the MODE (▲ or ▼) button until ECON is displayed.
- Press the (+) button to activate Sleep Mode. Moon & Stars icon will appear on the screen of the control panel, indicating this feature has been activated.

To deactivate this feature, simply repeat steps A-C then press the (-) button.



## FILTER CYCLES

When the spa is first powered up, the automatic filter cycle will wait 10 minutes before starting. Your spa will automatically turn the first filter cycle on for 60 minutes on low speed. The second filter cycle will activate for 30 minutes, 12 hours later. The filter cycle icon, F1 or F2 will be displayed in the control panel during the filter cycle.

**NOTE:** The optional **FRESHWATER** III ozone system only works during the filter cycle.

To modify the length of either filter cycle:

- A. Press the MODE (▲ or ▼) button until the TOOLS menu is displayed.
- B. Press the (+) button to enter the TOOLS submenus.
- C. Press the MODE (▲ or ▼) button until FILT1 or FILT2 is displayed.
- D. Press the (+) button to enter FILT1 or FILT2. F1 or F2 icon will flash.
- E. Using the (+) or the (-) button, adjust the desired filter cycle time, from 0 to 6 hours.

The filter cycle will activate the jet pump on low speed for the entire cycle. When activated, the filter cycle icon on the display is turned on. If the temperature exceeds the set point by three degrees F for more than three hours, the system will cancel the filter cycle for the remaining filter cycle time. Should the temperature cool down to 1.5 degrees F (1 degree C) below the set point before the end of the cycle, the cycle will resume for the rest of the time. Should you use the spa during the filter cycle by placing the jet pump on high speed, the Filter icon and Jets icon will be on. Once the jet pump has been shut off, a ten minute tranquil mode begins (Filter & Jet icons are off during tranquil mode while F1 or F2 remain lit). The Filter and Jet icons will come back on once the tranquil mode ends if the filter cycle timer is still on.



## BRIGHTNESS - LCD

If you would like to change the brightness of the Control Panel screen:

- A. Press the MODE (▲ or ▼) button until the TOOLS menu is displayed.
- B. Press the (+) button to enter the TOOLS submenus.
- C. Press the MODE (▲ or ▼) button until LCD is displayed.
- D. Press the (+) button to enter into the LCD menu.
- E. Using the (+) or the (-) button, adjust the desired screen brightness.



## AUDIO MENU (OPTIONAL)

The following applies to spas that have an optional wireless audio system installed:

When the wireless audio system has been installed on the spa, the control panel can be used to control the audio system. The following information demonstrates how to navigate the music menu by using the spa's control panel.

### AUDIO MENU

Once the music system is installed, an AUDIO menu will be accessible on the control panel screen. To access the menu, press the MODE (▲ or ▼) button until AUDIO is displayed.

### BASIC CONTROL PANEL OPERATION

- To enter into a sub-menu press the (+) button.
- To move to the next menu press the MODE (▲) button
- To exit from any sub-menu, press MODE (▲ or ▼) button as many times as necessary until EXIT is displayed then press the (+) button to exit that sub-menu.

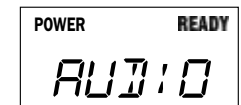

### TO TURN AUDIO SYSTEM ON/OFF

From the AUDIO screen:

1. Press the (+) button to display POWR -.
2. Press the (+) button to display POWR + and turn the audio system ON. Press the (-) button to display PWR - and turn the audio system OFF.

**IMPORTANT:** The power can take a few seconds to turn on or off.

### TO ADJUST VOLUME

From the AUDIO screen:

1. Press the (+) button to display POWR.
2. Press the MODE (▲) button to display VOL.

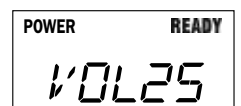
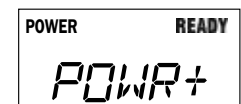



3. Press the (+)button to increase volume and the (-)button to decrease volume.

**NOTE:** Volume range is from 0-40. No number displayed indicates Volume is OFF.

## **TO PAUSE/PLAY**

From the AUDIO screen:

1. Press the the (+)button to display POWR.
2. Press the MODE (▲) button to display VOL.
3. Press the MODE (▲) button to display PLAY.
4. Press the (+)button to start the song or the (-)button to pause the song.

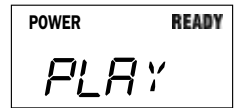

## **TO CHANGE TRACK**

From the AUDIO screen:

1. Press the the (+)button to display POWR.
2. Press the MODE (▲) button to display VOL.
3. Press the MODE (▲) button to display PLAY.
4. Press the MODE (▲) button to display TRCK +.
5. Press either (+)button or (-)button to change the track (song).



## **TO GO TO SETUP MENU**

From the AUDIO screen:

1. Press the (+)button to display POWR.
2. Press the MODE (▲) button to display VOL.
3. Press the MODE (▲) button to display PLAY.
4. Press the MODE (▲) button to display TRCK +
5. Press the MODE (▲) button to display SETUP.

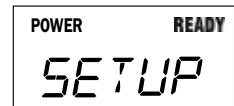

## **TO CHANGE AUDIO SOURCE**

From the SETUP screen:

1. Press the (+)button to display one of four audio sources, IPOD,TV, AUX, BLUE.
2. Press the (+)button to raise to the next source or press the (-)button to lower to the next source. Go to the source you will be using.

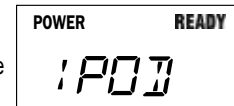

**NOTE:** Blue = Bluetooth®. To use the Bluetooth screen, your audio Bluetooth device must be paired with the spa. On your device, find *My Spa*. If you do not see this on your device you may be too far away from spa or your Audio Source is not set to BLUE. Pair your device and you will be ready to use the Bluetooth. Audio must be On to use Bluetooth. Only one paired Bluetooth device will work at a time.

## **TO ADJUST TREBLE**

From the SETUP screen:

1. Press the (+)button to display one of four audio sources, IPOD,TV, AUX, BLUE.
2. Press the MODE (▲) button to display TRE -5 to +5.
3. Press (+)button to raise the Treble or press (-)button to lower the treble.

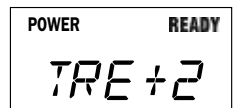

## **TO ADJUST BASS**

From the SETUP screen:

1. Press the (+)button to display one of four audio sources, IPOD,TV, AUX, BLUE.
2. Press the MODE (▲) button to display TRE.
3. Press the MODE (▲) button to display BAS -5 to +5.
4. Press (+)button to raise the Bass or press (-)button to lower the Bass.

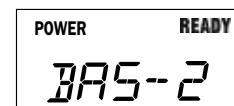

## TO ADJUST BALANCE

From the SETUP screen:

1. Press the (+) button to display one of four audio sources, IPOD, TV, AUX, BLUE.
2. Press the MODE (▲) button to display TRE.
3. Press the MODE (▲) button to display BAS.
4. Press the MODE (▲) button to display BAL -5 to +5.
5. Press (+) button to raise the Balance # or press (-) button to lower the Balance #.

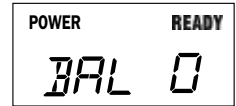

## TO ADJUST SUBWOOFER

From the SETUP screen:

1. Press the (+) button to display one of four audio sources, IPOD, TV, AUX, BLUE.
2. Press the MODE (▲) button to display TRE.
3. Press the MODE (▲) button to display BAS.
4. Press the MODE (▲) button to display BAL.
5. Press the MODE (▲) button to display SUB 0 to 11.
6. Press (+) button to raise the subwoofer # or press (-) button to lower the subwoofer #.

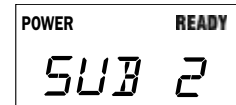

## TO CHANGE AMPLIFIER CHANNEL (TO MATCH WIRELESS DOCK TRANSMITTER INSIDE HOUSE IF INSTALLED)

From the SETUP screen:

1. Press the (+) button to display one of four audio sources, IPOD, TV, AUX, BLUE.
2. Press the MODE (▲) button to display TRE.
3. Press the MODE (▲) button to display BAS.
4. Press the MODE (▲) button to display BAL.
5. Press the MODE (▲) button to display SUB.
6. Press the MODE (▲) button to display CHAN 1-5.
7. Press (+) button to raise the channel # or press (-) button to lower the channel #.

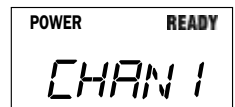

**NOTE:** Channel number must match Transmitter number inside house to work properly

## SPA CONTROL PANEL- SX & TX MODELS ONLY

Your control panel consists of an LED display and convenient touch pads that allow you to set the water temperature and adjust the skim/filter cycle settings, lock spa temp, lock entire spa functions, as well as control the hydrotherapy jets, and lights from spa-side.

### LED DISPLAY

The LED display on your spa-side control panel continually shows the spa's actual water temperature. In certain situations, it will also display other messages. See TROUBLESHOOTING section.

### SET BUTTON

Use the set button to control clean cycle, filter cycle, locking and light functions. To activate the desired mode, press the **SET** button. When the "SET" icon flashes push the applicable button. The SET mode ends after 3 seconds or when the "SET" icon stops flashing.

### TEMPERATURE CONTROL



The set temperature range is from 80°F (26°C) to 104°F (40°C). Temperatures of any setting may rise slightly depending on the current use and condition of your spa, and on outside temperature. Whenever power is disconnected and then reconnected to the spa, the water temperature setting will automatically return to the last temperature entered into the program.

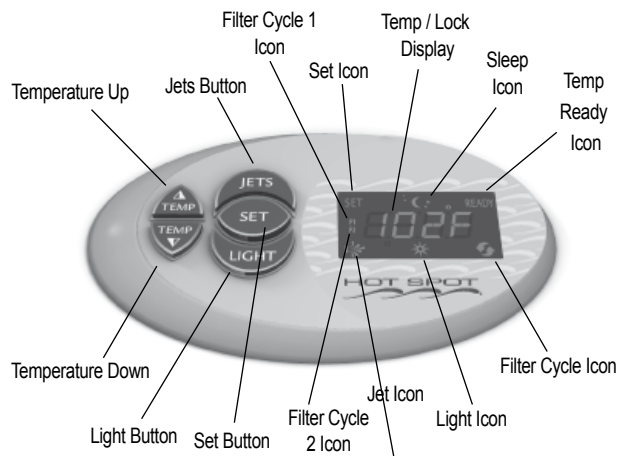

Pressing the **TEMP UP (▲)** button displays the spa's set temperature. To increase the set temperature, press the **TEMP UP (▲)** button again, once for each degree of increased temperature desired. If you hold the **TEMP UP (▲)** button down, the set temperature will increase by one degree every half second.

Pressing the **Temp Down (▼)** button displays the spa's set temperature. To decrease the set temperature, press the **Temp Down (▼)** button again, once for each degree of decreased temperature desired. If you hold the **Temp Down (▼)** button down, the set temperature will decrease by one degree every half second.

## JET PUMP CONTROL

Pressing the **JET** button for the SX & TX changes the jet pump functions, depending on the number of presses:

- 1st press: Two-speed jet pump runs on low speed
- 2nd press: Two-speed jet pump runs on high speed
- 3rd press: Jet pump is off



**NOTE:** The **MOTO-MASSAGE** jet will not function properly with the jet pump on low speed.

- During filter cycles or when the thermostat is calling for heat, the pump's low speed operates automatically.
- The pump on high speed automatically turns off after operating for two hours. The pump on low speed automatically turns off after operating for two hours.
- When the jets are active, the JETS icon on the control panel will illuminate.

## LIGHT - ON/OFF & INTENSITY CONTROLS

The light control uses four positions: High, Medium, Low, and Off. To turn on the spa light, press the LIGHT button. This will place all lights in the spa in the High, or maximum intensity position. When the lights turn on, the light symbol will also illuminate on the control panel display. Press the LIGHT button again to lower the intensity of the lights to the Medium position. Press the LIGHT button again to lower the intensity even more, placing the lights intensity in the Low position. Press the LIGHT button one more time to shut the lights off. When the light is deactivated, the light symbol will also turn off.

If the lights are left on, they will automatically be turned off by the control system after 6 hours of continuous operation. The light symbol on the panel will also turn off when the lights are deactivated.

If the lights will not turn on, make sure SPA LOCK is deactivated. SPA LOCK disables the controls on the control panel (see following pages for more information on SPA LOCK).

## SYSTEM MODE

Your spa is equipped with a System Mode. This function will allow you to conveniently turn the jet(s) on high speed and the light on maximum intensity at the same time.

To activate the system mode, perform the following functions:

Press the SET button until SYSON is displayed on the screen. Press the TEMP ▲ button to activate the SYSON mode feature. The jets and light icons will illuminate on the display until the system mode is deactivated.

**NOTE:** Once activated, the jet and light functions can still be changed by pressing the JETS or LIGHT button.

To deactivate the system mode, press the SET button until SYSON symbol is displayed on the screen. Press the TEMP ▼ button to deactivate.

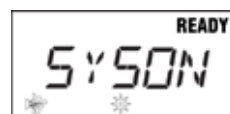

## CLEANING MODE

All spas are equipped with a "Cleaning" mode. When the mode is activated, the jet pump in the first jet system will turn on and run for ten minutes (used for water maintenance). To activate the "Cleaning" mode, press the SET button several times until the CLEAN menu is displayed. Press the TEMP ▲ button to activate the CLEAN mode feature.

**NOTE:** The jet icon will flash on and off while the "Cleaning" mode is active.

To stop the Cleaning Cycle before the ten minutes is complete, Press the SET button several times until the CLEAN menu is displayed then press the TEMP ▼ button to deactivate.

**NOTE:** Pressing the JETS button will also deactivate the clean cycle and the jet icon will remain on and solid



## TOOLS MENU

The TOOLS menu is one of the main menus on the control panel. Within the TOOLS menu are seven submenus, which consists of; Temp Lock, Spa Lock, Light, Econ or Summer Timer, Filter 1, Filter 2 and Exit.

To enter into the TOOLS menu, scroll through the main menus using the SET button until the TOOLS menu is displayed. Press the TEMP ▲ button to enter into the TOOLS submenu, use the SET button to scroll through the submenus. Once the desired submenu is displayed, press the TEMP ▲ button to activate the submenu. To leave the TOOLS submenu, scroll through the submenu until EXIT is displayed, press the TEMP ▲ button to exit the submenu.

## LOCKING FEATURES

The two locking features, SPA LOCK and TEMPERATURE LOCK, are enabled from the control panel by pressing the SET button until the TOOLS menu is displayed. Then press the TEMP ▲ button to enter the TOOLS submenus. Use the SET button to scroll through the submenus to get to the locking features. Once enabled, a lock will remain active until the specific button combination is applied to disable the lock. Even if power is disconnected from the spa and soon thereafter reapplied (such as in a power outage) the lock will remain in place.

### TEMPERATURE LOCK

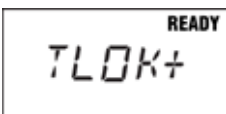

The TEMPERATURE LOCK feature deactivates the temperature control function of the control panel. The jets and the light functions will operate normally. TEMPERATURE LOCK is most often used by people who do not want others to tamper with or change the set temperature of the spa water. TEMPERATURE LOCK is a submenu of the TOOLS menu

To activate the TEMPERATURE LOCK, press the SET button in the TOOLS submenu until the TLOK- symbol is displayed on the screen. Press the TEMP ▲ button to activate the TEMPERATURE LOCK feature (TLOK+).

When the TEMPERATURE LOCK is activated, the JETS, LIGHT and any other features your spa may have will operate normally, and the temperature setting can be viewed but can NOT be changed. If a temperature button is pressed, TLOK will display for several seconds, then turns off.

To deactivate the TEMPERATURE LOCK, press the SET button in the TOOLS submenu until the TLOK+ symbol is displayed on the screen. Press the TEMP ▼ button to deactivate the TEMPERATURE LOCK feature.

### SPA LOCK

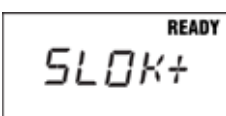

The SPA LOCK feature deactivates all of the functions of the control panel. It is generally used to prevent unwanted use of the spa. The SPA LOCK menu is a submenu of the TOOLS menu.

To activate the SPA LOCK, press the SET button in the TOOLS submenu until SLOK- is displayed on the screen. Press the TEMP ▲ button to activate the SPA LOCK feature.

When the SPA LOCK is activated, the buttons for the jets, temperature control, light, and any other features your spa may have are deactivated. If Jets, Light button, or Temp ▲ or TEMP ▼ button is pressed, the SLOK will display for several seconds, then turns off.

To deactivate the SPA LOCK, press the SET button in the TOOLS submenu until the SLOK+ symbol is displayed on the screen. Press the TEMP ▼ button to deactivate the SPA LOCK feature.

### LOCK OVERRIDE

The Lock Override feature is for spa users who normally keep the set temperature locked. Should the user wish to lock all spa controls temporarily, the spa lock can be applied over an already-applied temperature lock. Then, when the spa lock is removed, the temperature lock will remain on to prevent unwanted tampering with the set temperature.

## SUMMER MODE (OPTIONAL ON SX & TX MODELS ONLY)

If your spa is equipped with a circulation pump it will also have a Summer Mode timer. The Summer Mode timer can be activated during extremely hot summer months if it becomes difficult to maintain water temperatures low enough for comfort. Upon switching to the ON mode, the circulation pump (which can add heat to the water through normal operation) and heater will immediately shut down for the next eight hours. Additionally, the summer mode display on the control panel will activate and remain active for as long as the summer mode is on. Following this eight hour period, the circulation pump and heater will automatically re-start and will operate normally for the next sixteen hours. The circulation pump and heater will continue to turn off for an eight hour period every day that the timer remains in the ON position. In this way, the amount of heat transferred to the spa water will be minimized. When the outside temperatures begin to cool, the Summer Mode timer should be turned to the OFF position (the summer mode icon on the main display will shut off). This is the efficient 24 hour circulation mode that keeps the heater operation and operating costs to a minimum during colder/heavier usage months.

**NOTE:** Whenever power is disconnected and then reconnected to the spa, the Summer Mode timer will reset starting with the 8-hour shutdown mode. If a different 8-hour shut down time is desired, deactivate the Summer timer Mode, then reactivate at the beginning of the desired eight-hour shut down time.

**IMPORTANT:** The Summer Mode will not lower the spa's water temperature below the ambient air temperature.

To activate the Summer Mode, simply follow these steps:

1. Set the temperature control to 80°F (26°C) if desired to prevent the heater from turning on during cooler times.
2. On the control panel press the SET button until the TOOLS menu is displayed. Then press the TEMP ▲ button to enter the TOOLS submenus. Press the SET button until SUMMR is displayed on the screen. Press the TEMP ▲ button to activate the Summer Timer mode. The Moon & Stars icon is on when in Summer Timer Mode.



The Summer Mode must be deactivated when cooler temperatures return. To do this, simply follow step 3.

3. To shut the Summer Mode off, press the SET button until the TOOLS menu is displayed. Then press the TEMP ▲ button to enter the TOOLS submenus. Press the SET button until SUMMR is displayed on the screen. Press the TEMP ▼ button to deactivate.

## SLEEP MODE (USED ON ALL MODELS WITHOUT A CIRCULATION PUMP)

The Sleep Mode operation is a feature that minimizes pump operation during quiet evening hours. For example, if Filter Cycle 1 (F1) is set to activate at 8:00 a.m., by default, Filter Cycle 2 (F2) will activate at 8:00 p.m. (12 hours later). During 8:00 p.m. to 8:00 a.m., if the spa should call for heat, the pump and heater will activate to heat the spa under normal temperature demand. However, when in Sleep Mode, should the spa call for heat, the pump and heater will be suspended after Filter Cycle 2 (F2) until the activation of Filter Cycle 1 (F1), at 8:00 a.m. to minimize pump activation during quiet evening hours.

**Important:** Power-up of the spa starts the F1 sequence. In order for the sleep mode to work in the evening hours, the spa must be powered up in the early morning hours. The Sleep Mode will always be active the 6-12 hours between the end of (F2) and the beginning of (F1) depending on how the filter cycle program is set.

**Note:** If temperature drops below 80° F (27° C), heater will automatically activate to prevent spa from freezing.

To activate Sleep Mode feature:

- A. Press the SET button until the TOOLS menu is displayed.
- B. Press the TEMP ▲ button to enter the TOOLS submenus.
- C. Press the SET button until ECON is displayed on the screen.
- D. Press the TEMP ▲ button to activate Sleep Mode. Moon & Stars icon will appear in the display of the control panel, indicating this feature has been activated.



To deactivate this feature, simply repeat steps A-C then press the TEMP ▼ button.

## FILTER CYCLES (USED ON ALL MODELS WITHOUT A CIRCULATION PUMP)

When the spa is first powered up, the automatic filter cycle will wait 10 minutes before starting. Your spa will automatically turn the first filter cycle on for 60 minutes on low speed. The second filter cycle will activate for 30 minutes, 12 hours later. The filter cycle icon, F1 or F2 will be displayed in the control panel during the filter cycle.

**NOTE:** The optional FRESHWATER III ozone system only works during the filter cycle.

To modify the length of either filter cycle:

- A. Press the SET button until the TOOLS menu is displayed.
- B. Press the TEMP ▲ button to enter the TOOLS submenus.
- C. Press the SET button until FILT1 or FILT2 is displayed on the screen.
- D. Press the TEMP ▲ button to enter FILT1 or FILT2. F1 or F2 icon will flash.
- E. Using the TEMP ▲ or the TEMP ▼ button, adjust the desired filter cycle time, from 0 to 6 hours.

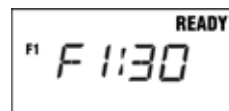
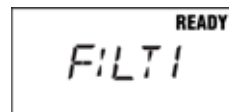

The filter cycle will activate the jet pump on low speed for the entire cycle. When activated, the filter cycle icon on the display is turned on. If the temperature exceeds the set point by three degrees F for more than three hours, the system will cancel the filter cycle for the remaining filter cycle time. Should the temperature cool down to 1.5 degrees F (1 degree C) below the set point before the end of the cycle, the cycle will resume for the rest of the time. Should you use the spa during the filter cycle by placing the jet pump on high speed, the Filter icon and Jets icon will be on. Once the jet pump has been shut off, a ten minute tranquil mode begins (Filter & Jet icons are off during tranquil mode while F1 or F2 remain lit). The Filter and Jet icons will come back on once the tranquil mode ends if the filter cycle timer is still on.

## AUDIO MENU (OPTIONAL)

The following applies to spas that have an optional wireless audio system installed:

When the wireless audio system has been installed on the spa, the control panel can be used to control the audio system. The following information demonstrates how to navigate the music menu by using the spa's control panel.

### AUDIO MENU

Once the music system is installed, an AUDIO menu will be accessible on the control panel screen. To access the menu, press the SET button on the control panel until AUDIO is displayed.

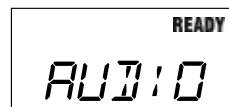

### BASIC CONTROL PANEL OPERATION

- To enter into a sub-menu, or to adjust the current function displayed, use the TEMP ▲ or TEMP ▼ buttons.
- To move to the next menu use the SET button.
- To exit from any sub-menu, press SET as many times as necessary until EXIT is displayed then press TEMP ▲ button to exit that sub-menu.



## TO TURN AUDIO SYSTEM ON/OFF

From the AUDIO menu:

1. Press the **TEMP ▲** button to display POWR -.
2. Press the **TEMP ▲** button to display POWR + and turn the audio system ON. Press the **TEMP ▼** button to display PWR - and turn the audio system OFF.

**IMPORTANT:** The power can take a few seconds to turn on or off.



## TO ADJUST VOLUME

From the AUDIO menu:

1. Press the **TEMP ▲** button to display POWR.
2. Press the SET button to display VOL.
3. Press the **TEMP ▲** button to increase volume and the **TEMP ▼** button to decrease volume.

**NOTE:** Volume range is from 0-40. No number displayed indicates Volume is OFF.

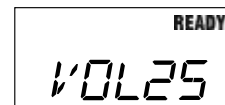

## TO PAUSE/PLAY

From the AUDIO menu:

1. Press the **TEMP ▲** button to display POWR.
2. Press the SET button to display VOL.
3. Press the SET button to display PLAY.
4. Press **TEMP ▲** button to start the song or **TEMP ▼** button to pause the song.

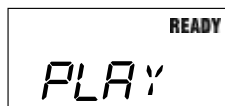

## TO CHANGE TRACK

From the AUDIO menu:

1. Press the **TEMP ▲** button to display POWR.
2. Press the SET button to display VOL.
3. Press the SET button to display PLAY.
4. Press the SET button to display TRCK +.
5. Press either **TEMP ▲** or **TEMP ▼** button to change the track (song).



## TO GO TO SETUP MENU

From the AUDIO menu:

1. Press the **TEMP ▲** button to display POWR.
2. Press the SET button to display VOL.
3. Press the SET button to display PLAY.
4. Press the SET button to display TRCK +.
5. Press the SET button to display SETUP.



## TO CHANGE AUDIO SOURCE

From the SETUP menu:

1. Press the **TEMP ▲** button to display one of four audio sources, IPOD, TV, AUX, BLUE.
2. Press the **TEMP ▲** button to raise to the next source or press **TEMP ▼** button to lower to the next source. Go to the source you will be using.

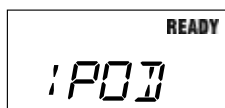

**NOTE:** Blue = Bluetooth®. To use the Bluetooth screen, your audio Bluetooth device must be paired with the spa. On your device, find *My Spa*. If you do not see this on your device you may be too far away from spa or your Audio Source is not set to BLUE. Pair your device and you will be ready to use the Bluetooth. Audio must be On to use Bluetooth. Only one paired Bluetooth device will work at a time.

## TO ADJUST TREBLE

From the SETUP menu:

1. Press the **TEMP ▲** to display one of four audio sources, IPOD,TV, AUX, BLUE.
2. Press the SET button **TEMP ▲** button to display TRE -5 to +5.
3. Press the **TEMP ▲** button to raise the Treble or press **TEMP ▼** button to lower the Treble.

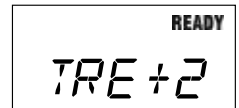

## TO ADJUST BASS

From the SETUP menu:

1. Press the **TEMP ▲** button to display one of four audio sources, IPOD,TV, AUX, BLUE.
2. Press the SET button to display TRE.
3. Press the SET button to display BAS -5 to +5.
4. Press the **TEMP ▲** button to raise the Bass or press **TEMP ▼** button to lower the Bass.

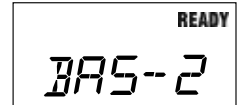

## TO ADJUST BALANCE

From the SETUP menu:

1. Press the **TEMP ▲** button to display one of four audio sources, IPOD,TV, AUX, BLUE.
2. Press the SET button to display TRE.
3. Press the SET button to display BAS.
4. Press the SET button to display BAL -5 to +5.
5. Press the **TEMP ▲** button to raise the Balance # or press **TEMP ▼** button to lower the Balance #.

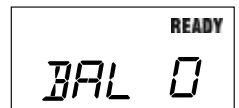

## TO ADJUST SUBWOOFER

From the SETUP menu:

1. Press the **TEMP ▲** button to display one of four audio sources, IPOD,TV, AUX, BLUE.
2. Press the SET button to display TRE.
3. Press the SET button to display BAS.
4. Press the SET button to display BAL.
5. Press the SET button to display SUB 0 to 11.
6. Press the **TEMP ▲** button to raise the subwoofer # or press **TEMP ▼** button to lower the Subwoofer #.

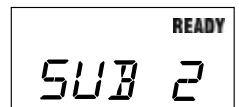

## TO CHANGE AMPLIFIER CHANNEL (TO MATCH WIRELESS DOCK TRANSMITTER INSIDE HOUSE IF INSTALLED)

From the SETUP menu:

1. Press the **TEMP ▲** button to display one of four audio sources, IPOD,TV, AUX, BLUE.
2. Press the SET button to display TRE.
3. Press the SET button to display BAS.
4. Press the SET button to display BAL.
5. Press the SET button to display SUB.
6. Press the SET button to display CHAN 1-5.
7. Press the **TEMP ▲** button to raise the channel # or press **TEMP ▼** button to lower the Channel #.

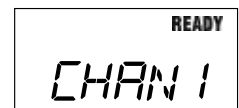

**NOTE:** Channel number must match Transmitter number inside house to work properly.

# TEMPO (MODEL TEM) JET SYSTEM MENU

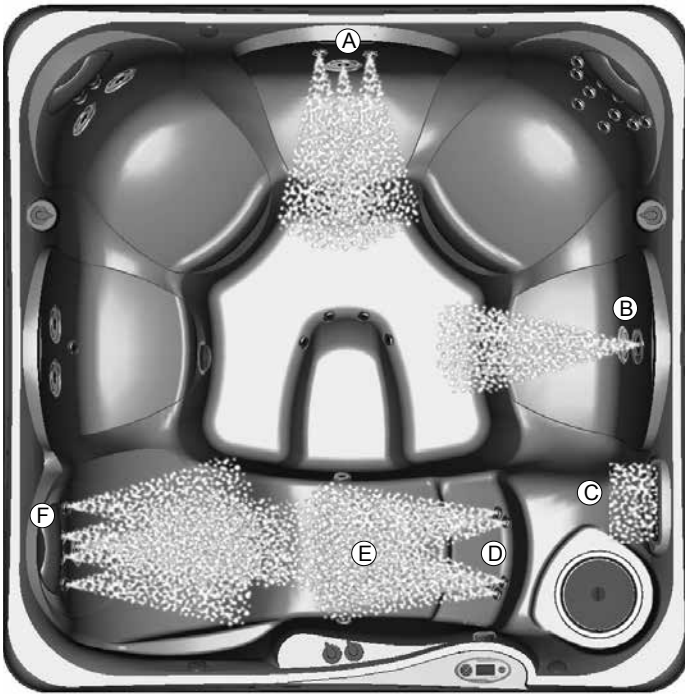

## JET PUMP 1

- A) 2 Directional **PRECISION** Jets and 1 Directional Hydromassage Jet
- B) 2 Directional Hydromassage Jets
- C) 1 Water Feature
- D) 6 Directional **PRECISION** Jets in Lounge (foot Jets)
- E) 4 Directional **PRECISION** Jets in Lounge (calf Jets)
- F) 1 Directional Hydromassage Jet, 2 Rotary Hydromassage Jets and 4 Directional **PRECISION** Jets



## JET PUMP 2

- A) 10 Directional **PRECISION** Jets
- B) 2 Directional Hydromassage Jets and 1 Directional **PRECISION** Jet
- C) 4 Directional **PRECISION** Jets and 2 Rotary Hydromassage Jets
- D) 4 Directional **PRECISION** Jets in footwell.

# RELAY (MODEL REL) JET SYSTEM MENU



## JET PUMP 1

- A) 2 Directional **PRECISION** Jets and 1 Directional Hydromassage Jet
- B) 8 Directional **PRECISION** Jets
- C) 2 Directional Hydromassage Jets
- D) 1 Water feature.
- E) 3 Directional **PRECISION** Jets
- F) 2 Directional **PRECISION** Jets



## JET PUMP 2

- A) 4 Directional **PRECISION** Jets (calf Jets)
- B) 2 Directional Hydromassage Jets, 1 Rotary Hydromassage Jet and 2 Directional **PRECISION** Jets
- C) 2 Directional **PRECISION** Jets and 2 Rotary Hydromassage Jets
- D) 2 Directional **PRECISION** Jets

# RHYTHM (MODEL RHY) JET SYSTEM MENU

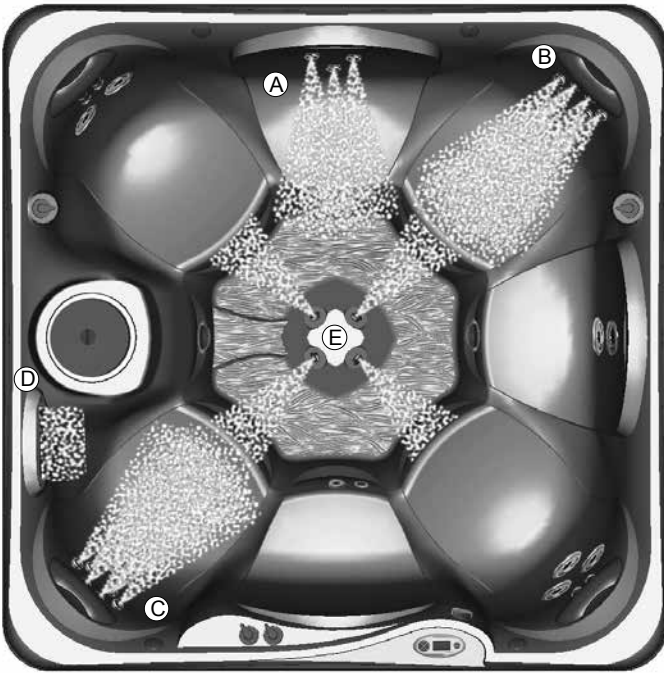

## JET PUMP 1

- A) 3 Directional **PRECISION** Jets
- B) 8 Directional **PRECISION** Jets
- C) 6 Directional **PRECISION** Jets and 1 Directional Hydromassage Jet
- D) 1 Water feature.
- E) 4 Directional **PRECISION** Jets

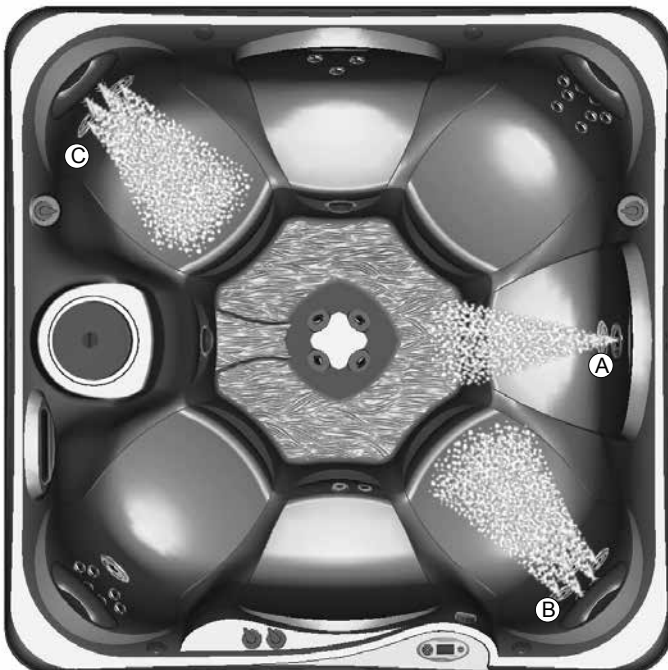

## JET PUMP 2

- A) 2 Directional Hydromassage Jets
- B) 2 Directional Hydromassage Jets, 1 Rotary Hydromassage Jet and 2 Directional **PRECISION** Jets
- C) 2 Rotary Hydromassage Jets and 4 Directional **PRECISION** Jets



# **SX (MODEL SX) JET SYSTEM MENU**



## **JET SYSTEM**

- A) 8 Directional **PRECISION** Jets
- B) 1 **MOTO-MASSAGE** Jet
- C) 2 Directional **PRECISION** Jets
- D) 2 Directional Precision Jets



# TX (MODEL TX) JET SYSTEM MENU



## **JET SYSTEM**

- A) 8 Directional **PRECISION** Jets
- B) 1 **MOTO-MASSAGE** Jet
- C) 1 Rotary Hydromassage Jet

# WATER QUALITY AND MAINTENANCE

It's important to have clean water. Water maintenance is one of the least understood, yet most important areas of spa ownership. Your dealer can guide you through the process of achieving and maintaining perfect water in your spa, given your local conditions. Your program will depend on your water's mineral content, how often you use your spa, and how many people use it.

Watkins recommends that you either use an entirely chlorine-based system, or an alternative system which uses silver ions (the **FRESHWATER<sub>Ag+</sub>** silver ion purifier). **HOT SPRING FRESHWATER** products, which Watkins recommends, are available from authorized **HOT SPOT** dealers.

## GENERAL INFORMATION

### THE THREE FUNDAMENTAL AREAS OF WATER MAINTENANCE:

- **Water Filtration**
- **Water Sanitation**
- **Chemical Balance/pH Control**

Water Sanitation is the responsibility of the spa owner, achieved through the regular and periodic (daily, if necessary) addition of an approved sanitizer. The sanitizer will chemically control the bacteria and viruses present in the fill water or introduced during use of the spa. Bacteria and viruses can grow quickly in undersanitized spa water.

The water's chemical balance and pH control are also the responsibility of the spa owner. You'll have to add chemicals to maintain proper levels of Total Alkalinity (TA), Calcium Hardness (CH) and pH. Proper water balance and pH control will minimize scale buildup, extend the life of the spa, and allow the sanitizer to work at top efficiency.

## METHODS FOR TESTING THE SPA WATER

Accurate water testing and analysis is an important part of effectively managing your spa water. You must have the ability to test for:

- Total Alkalinity (TA)
- Calcium Hardness (CH)
- pH
- Sanitizer

Two types of testing methods are recognized and recommended by Watkins:

**The Reagent Test Kit** is a method which provides a high level of accuracy. The reagents come in either liquid or tablet form.

**FRESHWATER Test Strips** are a convenient testing method used by many spa owners. Keep in mind that test strips are susceptible to heat and moisture contamination, which will result in inaccurate readings.

**IMPORTANT:** Always read and carefully follow the directions included with the Test Kit or Test Strips to ensure the accuracy of the test results.

## BASIC CHEMICAL SAFETY

When using chemicals, read the labels carefully and follow directions precisely. Though chemicals protect you and your spa when used correctly, they can be hazardous in concentrated form. Always observe the following guidelines:

- Allow only a responsible person to handle spa chemicals. Keep them out of the reach of children.
- Accurately measure the exact quantities specified, never more. Do not overdose your spa.
- Handle all containers with care. Store in a cool, dry, well ventilated place.
- Always keep chemical containers closed when not in use. Replace caps on their proper containers.
- Follow the emergency advice on the product label in case of accidental contact, or if the chemical is swallowed. Call a doctor or the local Poison Control Center. If a doctor is needed, take the product container along so that the substance can be identified.
- Don't inhale fumes or allow chemicals to come in contact with your eyes, nose, or mouth. Wash your hands immediately after use.
- Don't let chemicals get on surrounding surfaces or landscaping.
- Don't use a vacuum cleaner to clean up chemical spills.
- Never smoke around chemicals. Some fumes can be highly flammable.
- Don't store any chemicals in the spa equipment compartment.

## HOW TO ADD CHEMICALS TO THE WATER

**IMPORTANT:** All spa water chemicals including MPS (shock), chlorine, granulated pH increaser or decreaser, granulated total alkalinity increaser, calcium hardness increaser, liquid stain and scale inhibitor, and liquid defoamer must always be added directly into the filter compartment while the jet pump is running in high speed mode, and it must run for a minimum of ten minutes.

## **TO ADMINISTER SPA WATER CHEMICALS:**

1. Fold back the spa cover.
2. Push the JET button twice to activate the jet pump's high speed mode.
3. Carefully measure the recommended amount of chemical and slowly pour it into the filter compartment. Use care not to splash chemicals on your hands, in your eyes, on the spa shell surface or on the siding.
4. After ten minutes, shut off the jet pump and close and lock the cover to complete the procedure. **Risk of Drowning:** Never leave an open spa unattended!

⚠ **WARNING:** High sanitizer levels can cause discomfort to the user's eyes, lungs and skin. Always allow the sanitizer level to fall to the recommended range before using the spa.

**NOTE:** After administering a super chlorination treatment or non-chlorine shock to your spa, leave the cover open for a minimum of twenty minutes to allow the oxidizer gas to vent. A high concentration of trapped oxidizer gas which may exist as a result of the shock treatment (not daily sanitation) may eventually cause discoloration or vinyl degradation to the bottom of the cover. This type of damage is considered chemical abuse and is not covered under the terms of the limited warranty.

## **THE HOT SPOT SPA WATER MAINTENANCE PROGRAM**

Each step in your water maintenance program is dependent on the completion of the previous steps. Omitting a step or failing to reach the recommended range may cause an imbalance in your water's chemistry. Unbalanced water chemistry can damage the spa and its components as well as cause discomfort for the user.

### **FILLING THE SPA WITH WATER**

- A. To prevent contaminants from entering the spa, Watkins Manufacturing Corporation recommends using the **CLEAN SCREEN** pre-filter when filling the spa with water. Always fill the spa through the filter compartment.
- B. The **CLEAN SCREEN** pre-filter is designed to remove unwanted contaminants such as rust, dirt, detergents and algae as well as iron, copper and magnesium from the fill water. Dissolved minerals and metals such as lead and calcium are not removed.
- C. Instructions are included with the **CLEAN SCREEN** pre-filter. When the spa is filled, proceed to the Start-Up and Refill Procedures on page 15.

### **BALANCING THE TOTAL ALKALINITY (TA)**

- A. The recommended Total Alkalinity (TA) for your spa water is 40-120 ppm.
- B. Total Alkalinity is a measure of the total levels of carbonates, bicarbonates, hydroxides, and other alkaline substances in the water. TA is referred to as the water's "pH buffer". In other words, it's a measure of the ability of the water to resist changes in pH level.
- C. If the TA is too low, the pH level will fluctuate widely from high to low. Fluctuations in pH can cause corrosion or scaling of the spa components. **Low TA can be corrected by adding FRESHWATER pH/Alkalinity Up or sodium hydrogen carbonate.**
- D. If the Total Alkalinity is too high, the pH level will tend to be high and may be difficult to bring down. **It can be lowered by adding FRESHWATER pH/Alkalinity Down or sodium bisulfate.**
- E. Once the TA is balanced, it normally remains stable, although the addition of more water with a high or low alkalinity will raise or lower the TA reading of the water.
- F. When the Total Alkalinity is within the recommended range, proceed to the next step.

### **BALANCING THE CALCIUM HARDNESS (CH)**

- A. The recommended Calcium Hardness (CH) level for your spa is 50-150 ppm.
- B. CH is a measure of the total amount of dissolved calcium in the water. Calcium helps control the corrosive nature of the spa's water. That's why calcium-low water (commonly known as "soft" water) is not recommended. It is very corrosive to the equipment, and can cause staining of the spa shell. If the calcium level is too low, we recommend using **FRESHWATER Calcium Increaser** to bring the calcium hardness level to within the recommended range.
- C. If the CH is too high (commonly known as "hard" water), formation of scale on the spa's shell surface and equipment can result. **CH can be decreased by using the Vanishing Act® calcium remover available from your HOT SPOT dealer.** [Additionally, a stain and scale inhibitor, such as **FRESHWATER Stain and Scale defense**, should be added to the spa water, according to label instructions.]
- D. Once the CH is balanced, it normally remains stable, although the addition of more water with a high or low calcium content will raise or lower the CH reading of the water.
- E. When the CH is within the recommended range, proceed to the next step.

## BALANCING THE PH

- A. The ideal pH level for your spa water is 7.2-7.6.
- B. The pH level is the measure of acidity and alkalinity. Values above 7.6 are alkaline; those below 7.2 are acidic. Maintaining the proper pH level is extremely important for:

- Optimizing the effectiveness of the sanitizer.
- Maintaining water that is comfortable for the user.
- Preventing equipment deterioration.

- C. If the spa water's pH level is too low, the following may result:

- The sanitizer will dissipate rapidly.
- The water may become irritating to spa users.
- The spa's equipment may corrode.

**If the pH is too low, it can be increased by adding sodium hydrogen carbonate, or FRESHWATER pH/Alkalinity Up, to the spa water.**

- D. If the pH level is too high, the following may result:

- The sanitizer is less effective.
- Scale will form on the spa shell surface and the equipment.
- The water may become cloudy.
- The filter cartridge pores may become obstructed.

**If the pH is too high, it can be decreased by adding sodium bisulfate, or FRESHWATER pH/Alkalinity Down, to the spa water.**

**NOTE:** After adding sodium hydrogen carbonate, or sodium bisulfate, **wait two hours** before testing the water for pH. Measurements taken too soon may not be accurate.

- E. It is important to check the pH on a regular (weekly) basis. The pH will be affected by the bather load, the addition of new water, the addition of various chemicals, and the type of sanitizer used.
- F. When the pH is within the recommended range, proceed to the final step.

## MAINTAINING THE SANITIZER LEVEL

- A. Sanitizer is extremely important for killing algae, bacteria and viruses, and preventing unwanted organisms from growing in the spa. At the same time, you don't want too high a sanitizer level, or it can irritate your skin, lungs and eyes.
- B. Always maintain the sanitizer level in your spa at the recommended level for each type of sanitizer.
- C. Watkins recommends the following sanitizers:

- Sodium Dichloro-s-Triazinetrione (sodium dichlor or chlorine)
- **BAQUASPA** (please consult your **BAQUASPA** manual for instructions on the use of this product).
- Brominating Concentrate (one step granular bromine)

⚠ **WARNING:** DO NOT use tri-chlor chlorine, bromo-chloro-dimethyl-hydantoin (BCDMH), or any type of compressed bromine or chlorine, acid, or any type of sanitizer which is not recommended by Watkins Manufacturing Corporation.

ALKALINE SPA WATER (SCALING ZONE)	7.8	ADD pH DECREASER TO LOWER pH
	7.6	
COMFORT ZONE      7.4      IDEAL		
7.2		
ACIDIC SPA WATER (CORROSIVE ZONE)	7.0	ADD pH INCREASER TO RAISE pH
	pH	

THE WATKINS WATER MAINTENANCE QUICK REFERENCE GUIDE					
Steps	Ideal Range (ppm)		What Chemicals to Use		
	Min.	Max.	To Raise	To Lower	
1 Total Alkalinity	40	120	Sodium Hydrogen Carbonate, or Sodium Bicarbonate	Sodium Bisulfate	
2 Calcium Hardness	50	150	Calcium Hardness Increaser	Use VANISHING ACT Calcium Remover	
3 pH	7.2	7.6		Sodium Bisulfate	
4 Sanitizer	See section on Maintaining the Sanitizer Level				

# FRESHWATER <sub>Ag+</sub> SILVER ION SYSTEM

The Silver ion system is comprised of the following products:

- **FRESHWATER**Sodium Dichlor
- **FRESHWATER**Monopersulfate (MPS)
- **FRESHWATER**<sub>Ag+</sub> silver ion purifier
- **CLEAN SCREEN** Pre-Filter

**CLEAN SCREEN Pre-Filter** is used when filling a spa for the first time, at top off, or at refill. It attaches to a garden hose and filters out rust, dirt, detergents, algae and chemicals.

**FRESHWATER Sodium Dichlor (chlorine)** is the only recommended sanitizer that will work in conjunction with all of the other products in this system..

**FRESHWATERMonopersulfate (MPS)** is an oxidizing chemical used to prevent the buildup of contaminants, maximize sanitizer efficiency, minimize combined chlorine, and improve water clarity.

**FRESHWATER<sub>Ag+</sub> silver ion purifier** introduces silver ions into the spa water, inhibiting bacteria growth. When combined with MPS, or chlorine, oxidizes particulates in the spa water.

It is important to follow the recommended application and maintenance programs outlined for each product's use.

If the spa is being used over an extended period of time, such as a whole afternoon or evening, additional sanitizer will be needed.

**A weekly "shock treatment" is required.**

The shock treatment quickly destroys any remaining contaminants while revitalizing the silver ion cartridge, allowing the silver ions to continue to be released into the water. Without this weekly shock treatment, the silver ion cartridge may stop releasing silver ions into the water.

To weekly "shock treat" your spa you may use either MPS or sodium dichlor. It will require much less sodium dichlor to administer the shock treatment than MPS (one teaspoon of sodium dichlor has oxidizing capabilities comparable to two tablespoons of MPS). Sodium dichlor may be a more appropriate weekly shock for those users that experience heavy bather load conditions.

**IMPORTANT NOTE:** MPS is an oxidizer, not a sanitizer.

## EVERFRESH WATER CARE SYSTEM

The **EVERFRESH** water care system is comprised of the **FRESHWATER<sub>Ag+</sub> Silver ion** and the **FRESHWATER III high output ozone system**

**FRESHWATER <sub>Ag+</sub> silver ion System** (see above).

**FreshWater III high output ozone system (Optional)** uses Corona Discharge technology to produce a high concentration of ozone, which is injected into the spa water

## FRESHWATER <sub>Ag+</sub> SILVER ION PURIFIER REPLACEMENT INSTRUCTIONS

When replacing the **FRESHWATER<sub>Ag+</sub> silver ion purifier** (every four months) it is highly recommended that the spa be drained and refilled at the same time. After refilling the spa with water, balance the Total Alkalinity (TA), Calcium Hardness (CH) and pH to the recommended levels. Shock the spa by adding sodium dichlor (See Sanitization Table for details).

1. Fold back the vinyl cover.
2. Remove any floating items within the filter compartment.
3. Locate the filter retainer handle. Turn the filter retain handle counterclockwise until the cap can be removed from the filter standpipe.
4. Remove and clean filter cartridges.  
**NOTE:** When replacing the **FRESHWATER<sub>Ag+</sub> silver ion purifier**, it is an excellent time to clean the filter to extend the life. Remove the existing **FRESHWATER<sub>Ag+</sub> silver ion purifier**.
5. Install the new **FRESHWATER<sub>Ag+</sub> silver ion purifier** into the filter standpipe as illustrated in the Silver Ion instructions.
6. Reinstall the cleaned filter cartridges.
7. Replace and secure the filter retainer handle or filter basket and cap.
8. Fold the cover back into place.

⚠ **WARNING:** Never use the spa with the filter cartridges or filter standpipes removed!

## HOT SPOT WATER TREATMENT GUIDE

<b>At spa startup or refill</b>	Follow Start-Up and Refill Procedures section	
<b>Prior to each use</b> (Test before adding any chemicals; do not add any chemicals if proper or higher levels are found.)	Add one-half (½) teaspoon of chlorine per 250-gallons (950 liters) <b>TEMPO</b> ¾ teaspoon <b>RELAY</b> ¾ teaspoon <b>RHYTHM</b> ¾ teaspoon SX            ¾ teaspoon TX            ¼ teaspoon	OR
	Add one (1) tablespoon of monopersulfate (MPS)* per 250-gallons (950 liters). <b>TEMPO</b> 1½ tablespoons <b>RELAY</b> 1½ tablespoons <b>RHYTHM</b> 1½ tablespoons SX            1¼ tablespoons TX            ½ tablespoon	
<b>Once a week</b>	Add one and one-half (1½) teaspoons of chlorine per 250-gallons (950 liters). <b>TEMPO</b> 2¼ teaspoons <b>RELAY</b> 2¼ teaspoons <b>RHYTHM</b> 2¼ teaspoons SX            1¼ teaspoons TX            ¾ teaspoon	OR
	Add three (4) tablespoons of monopersulfate (MPS)* per 250-gallons (950 liters). <b>TEMPO</b> 4½ tablespoons <b>RELAY</b> 4½ tablespoons <b>RHYTHM</b> 4½ tablespoons SX            3¾ tablespoons TX            1½ tablespoon	
<b>Every four months</b>	Drain spa, replace cartridge (if applicable), and refill your spa. Follow spa Start-Up and Refill Procedures	
<b>As needed</b> (if water is hazy, cloudy or has an odor)	Add one and one half (1½) teaspoons of sodium dichlor per 250-gallons (950 liters).	
	<b>TEMPO</b> 2¼ teaspoons <b>RELAY</b> 2¼ teaspoons <b>RHYTHM</b> 2¼ teaspoons SX                    1¼ teaspoons TX                    ¾ teaspoon	

## SILVER IONS QUESTIONS AND ANSWERS

**Question:** How are the silver ions actually added to the water?

**Answer:** The silver ion cartridge contains ceramic beads that are infused with silver. By placing the cartridge in the circulation pump filter standpipe, it is subjected to the continuous flow of water created by the pump's 24 hour circulation. The flowing water, through a chemical erosion process, carries with it the silver ions necessary to add a sanitizing residual to the spa water.

**Question:** What happens if I do not add the weekly shock treatment?

**Answer:** The contaminants in the water may coat the silver ion cartridge's ceramic beads, blocking the silver ions' release into the water. When this occurs, there will be no residual of silver ions present in the water, eliminating them from the sanitizing process.

**Question:** How often should the **FRESHWATER<sub>Ag+</sub>** silver ion purifier cartridge be replaced?

**Answer:** The cartridge must be replaced every four months. Please refer to the instructions provided with each **FRESHWATER<sub>Ag+</sub>** silver ion purifier cartridge.

**Question:** Can I use the **FRESHWATER III** ozone system in addition to the silver ion system?

**Answer:** Yes. In fact, it is preferred! The use of the **FRESHWATER III** ozone system will enhance the performance of the silver ions and may substantially reduce the need for supplemental chemical treatments when the spa is not in use.

**Question:** Why can't I use bromine or biguanides instead of MPS or chlorine?

**Answer:** Bromine and biguanides will chemically react with the sanitizing action of the silver ions. This will eliminate their beneficial sanitizing effect.

### DOS AND DON'TS

- DO check your MPS or dichlor chemical level prior to each use.
- DO shock the spa weekly (use either MPS or sodium dichlor).
- DO change the **FRESHWATER<sub>Ag+</sub>** silver ion purifier every four months.
- DO test Total Alkalinity and pH weekly.



- DO use MPS for spas only, such as **HOT SPRING** MPS chlorine-free oxidizer.
- DO store all chemicals in a tightly sealed container in a cool, dry place.
- DON'T use bromine, sodium bromide or biguanides. These are an active sanitizer and will combine with the silver ions to inactivate them.
- DON'T use a water clarifier. Clarifiers will cause the spa water to become cloudy.

## CHLORINE (SODIUM DICHLOR)

- Sanitizing chemicals, such as chlorine, are oxidants that kill bacteria and viruses in the water. The Free Available Chlorine (FAC) is a measure of the amount of unused chlorine available to sanitize the spa. The recommended FAC for your spa water is 3.0-5.0 ppm.
- Watkins Manufacturing Corporation recommends the use of **HOT SPRING FRESHWATER** Concentrated Chlorinating Granules (sodium dichlor) for sanitizing the water. Sodium dichlor is preferred because it is totally soluble, dissolves quickly and is nearly pH neutral.
- Maintaining the proper level of chlorine during use is extremely important.
- If the FAC is too low, bacteria and viruses can grow rapidly in the warm water. **Increase the FAC by adding granulated sodium dichlor.**
- If the FAC is too high, the water can cause discomfort to the user's eyes, lungs and skin. **Simply allow some time to pass. The FAC level will naturally drop over time.**
- When the Free Available Chlorine is within the recommended range, the spa is ready to be enjoyed.

⚠ **WARNING:** There are several forms of stabilized chlorine available for use in spas and swimming pools and each form has specific chemical characteristics. It is extremely important that the one you choose is specifically designed for use in spas. Use of an incorrect product such as tri-chlor, which has a very low pH (2.6), dissolves too quickly in hot water resulting in extremely high levels of chlorine, and is designed for concrete or plaster swimming pools, **WILL** cause damage to your spa. Use of a liquid or any type of compressed bromine or chlorine, acid or any type of sanitizer which is not recommended by Watkins Manufacturing Corporation **WILL** damage your spa and is specifically not covered under the terms of the limited warranty.

**IMPORTANT:** Granulated chlorine (sodium dichlor) will degrade if stored improperly. We recommend purchasing chlorine in one, two, or four pound containers and storing it in a cool, dry place to maintain its potency.

## SUPER CHLORINATION

Super Chlorination is designed to "burn-off" the build-up of chloramines (used chlorine), to eliminate the chlorine smell and to allow the proper level of free chlorine to be maintained.

When giving your water a super chlorination treatment, open the cover at least half way for twenty minutes to allow the chlorine gas to vent off. The high concentration of chlorine gas which may exist as a result of super chlorination (not daily sanitation) may eventually cause discoloration or degradation to the bottom of the cover, which would not be covered under the terms of your warranty.

⚠ **WARNING:** There are several forms of stabilizer chlorine available for use in spas and swimming pools. Each form has specific chemical characteristics. It is extremely important that the form you choose is specifically designed for use in spas. Use of an incorrect product such as tri-chloro, which has a very low pH (2.6) dissolves too quickly in hot water resulting in extremely high levels of chlorine, and is designed for concrete or plaster swimming pools. **WILL** cause damage to your spa. Use of a liquid, or any type of compressed bromine or chlorine, acid, or any type of sanitizer which is not recommended by Watkins Manufacturing Corporation, **WILL** damage your spa and is specifically not covered under the terms of the limited warranty.

CHLORINE DPD TEST KIT OR TEST STRIP READING	DO NOT USE THE SPA UNTIL THE TEST KIT READING IS BELOW THIS LEVEL
5.0	RECOMMENDED LEVEL <b>SAFE</b>
4.0	
3.0	
<b>ADD CHLORINE</b>	
2.0	DO NOT USE SPA; ADD CHLORINE TO REACH RECOMMENDED SAFE LEVEL
1.0	
0	

## SUPPLEMENTAL WATER MAINTENANCE

Proper water sanitation and mineral balance (pH control) are absolutely essential for a complete spa water maintenance program. Here are three other popular water additives that are optional:

### MINERAL DEPOSIT INHIBITORS

As water evaporates from your spa and new water is added, the amount of dissolved minerals will increase. (Minimize evaporation by keeping the cover on the spa whenever possible.) The spa water may eventually become "hard" (Calcium Hardness too high) enough to damage the heater by calcifying its surface. Proper pH control can minimize this. To reduce hardness, use the **VANISHING ACT** calcium remover.

Normal soap build-up will require water replacement regularly enough that mineral deposits normally are not a problem.

Occasionally, high iron or copper content in the water may produce green or brown stains on the spa. Using the **CLEAN SCREEN** pre-filter when adding water to the spa will help to reduce these metals.

**NOTE:** Well water may contain high concentrations of minerals. The use of a low water volume, extra-fine pore water filter (such as the **CLEAN SCREEN** pre-filter) will help to remove many of the larger particles during the filling of the spa. **CLEAN SCREEN** pre-filters can be purchased at your local **HOT SPOT** Spa Dealer.

## FOAM INHIBITORS

Spa water requires changing due to the build-up of soap in the water. Typically, soap will cause the spa water to foam when the jets are used. Soap is introduced into the spa water from two sources; users' bodies, which retain a soap residue after showering, and swimming apparel, which retains soap after washing.

Foam inhibitors, such as **FRESHWATER** Defoamer, can suppress foam, but cannot remove soap from the water. Soap is very difficult to remove from the water because soap is not oxidized by any chemical added to the spa. Only ozone can oxidize soap.

Eventually the soap build-up in the water will be concentrated, resulting in an unclean feeling on the bather's skin, which is impossible to remedy. When this occurs, it's time to drain and refill the spa. Depending on the soap input, the water should last about 4 months before needing to be drained.

## OZONE (OPTIONAL)



The **FRESHWATER** III high output ozone system is the Watkins recommended ozone purification system for your spa. The **FRESHWATER** III ozone system utilizes Corona Discharge (CD) technology to produce a higher concentration of ozone than is produced by competing ultraviolet light (UV) ozone systems.

The **FRESHWATER** III high output ozone system greatly enhances the quality of the spa water when used to supplement the spa owner's regular water maintenance program. Contrary to some information circulated throughout the pool and spa industry regarding ozone systems, ozone CAN NOT be used as a single-source sanitizer, water clarifier, anti-foamer, and mineral chelating agent. A secondary-source sanitizer must be used to maintain 2.0 ppm (2.0 mg/L) of Free Available Chlorine (FAC). Watkins Manufacturing Corporation recommends that a chemical maintenance program based on recognized and documented industry standards still be followed when using an ozone purification system to assure water sanitation and the highest quality purified water.

## CLEANING THE OZONE INJECTOR

On occasion, a mineral build-up may clog the ozone injector causing a lack of flow or low flow of ozone bubbles. To prevent this, refer to the following instructions to clean the injector:

1. Disconnect power to the spa.
2. Access the equipment compartment.
3. Locate the ozonator in the equipment compartment and unplug the ozonator from the control box.

 <p><b>WARNING</b></p>	<p>Nitric acid accumulates in the air lines of the ozonator and injector. Nitric acid will cause severe chemical burns if direct skin contact is made, so always wear protective gloves, glasses and clothing when working on the ozonator or injector lines. To prevent inhalation or ingestion of the nitric acid, DO NOT blow or inhale with your mouth to any of the adapters, fittings or tubing of the ozonator or injector air lines.</p>	 <p><b>WARNING</b></p>
--	--	--

4. Place 16 ounces (1/2 liter) of white vinegar into a container such as a cup or bucket. Place the container on the equipment compartment floor. NOTE: White vinegar will not damage any of the spa components.
5. Carefully loosen the long Tygon / Kynar tubing to the bottom of the ozonator. **A liquid substance may be found inside the tubing. If a liquid substance is present, BE CERTAIN NOT TO COME INTO CONTACT WITH THE LIQUID (SEE WARNING ABOVE).**
6. Place the end of the tubing into the vinegar, making certain that the end of the tubing sits at the bottom of the container.
7. Reconnect power to the spa.
8. Run the spa until all 16 ounces (1/2 liter) of the vinegar are gone. This should allow an ample flow of vinegar to be run through the injector and clear the blockage.
9. Disconnect power to the spa.
10. Remove the empty cup or bucket.
11. Reinstall the tubing to the bottom of the ozonator.
12. Plug the ozonator into the control box.
13. Close the equipment compartment door.
14. Reconnect power to the spa.

**IMPORTANT:** When using the **FRESHWATER** III high output ozone system, the filter cycle must be activated to ensure adequate ozone circulation. Refer to the circulation cycle in the HEATING AND HYDROMASSAGE SYSTEM section for more information.

## DO'S AND DON'TS

- **DO** add all chemicals slowly into the filter compartment with the jet pump operating on high speed for ten minutes.
- **DO** use special care if using baking soda to clean either the interior or exterior plastic surfaces.
- **DO** use only a granular form of sanitizer.
- **DON'T** use swimming pool (muriatic) acid to lower pH.
- **DON'T** splash pH increaser additives on the siding.
- **DON'T** use Compressed Sanitizers.

The use of bromine sticks or tablets in floaters, which may become entrapped in a lounge or cooling seat (or sink to the spa floor), have been shown to cause discoloration of or surface distress to a spa's shell.

- **DON'T** use a floater type sanitization system as a low or no maintenance solution to your spa maintenance program.

The spa shell can easily withstand the effects of a properly administered sanitizer. Floating dispensers can become trapped in one area and cause an over-sanitization (or chemical burn) of that particular area.

If the dispenser setting is too high, the high concentration can discolor the spa shell and damage the underside of the cover.

Automatic floating dispensers have a tendency to either over-brominate or under-brominate as the rate of erosion varies greatly. Damage to the spa and cover can occur very quickly.

⚠ **WARNING:** Watkins Manufacturing Corporation **DOES NOT** recommend the use of any floating chemical dispenser. Damage to the spa shell or components caused by a floating chemical dispenser is specifically not covered under the terms of the limited warranty.

- **DON'T** use a sanitizer which is not designed for spas.
- **DON'T** use household bleach (liquid sodium hypochlorite).
- **DON'T** broadcast or sprinkle the chemicals onto the water surface. This method may cause chemically-induced spa surface blistering (chemical abuse).

## COMMON WATER CHEMISTRY QUESTIONS

**Question:** Why can't I use a floater to sanitize my spa water?

**Answer:** Watkins Manufacturing Corporation does not recommend the use of a floater for three reasons:

1. The floater is unable to control the rate at which the sanitizer is dissolved into the water. When a floater is first placed in a spa, the sanitizer level can be extremely high. High sanitizer levels can chemically burn or discolor the spa's shell or the underside of the cover. Then, after a period of time, the sanitizer level dispensed by the floater will fall to near zero. A low sanitizer level will allow viruses, bacteria, or algae to grow.
2. Floaters tend to stay in one area of the spa most of the time (usually over the cool-down seat), causing this area to be exposed to extreme sanitizer levels.
3. The floater may allow pieces of the highly concentrated sanitizer to fall out and settle on the floor or seat of the spa shell. These pieces of sanitizer will chemically burn (blister) the spa shell. Although your spa shell is specifically designed to resist the effects of spa chemicals, no spa surface can withstand this type of highly concentrated chemical. Remember, chemical abuse is specifically not covered under the terms of the warranty.

**Question:** When I open my spa, I smell chlorine. How do I get rid of this smell?

**Answer:** There are two types of chlorine in your spa. The first is the Free Available Chlorine, which is the chlorine available to sanitize your spa. This Free Available Chlorine does not have an odor. The second is Chloramine, which is residue from chlorine already expended. Chloramines have a strong chlorine odor. The smell from Chloramines can be eliminated by "shocking" the water. If you smell chlorine in the water, your spa is reminding you to add a shock treatment.

**Question:** Why can't I fill my spa with soft water?

**Answer:** Soft water is essentially the same as regular water except that all of the calcium has been replaced by sodium. Soft water may be corrosive to the heater and other components. Replacement of spa components damaged by soft water is extremely expensive.

**Question:** I am trying to reduce the number of chemicals to which my family is exposed. Do I really need to use so many chemicals and in such large amounts?

**Answer:** While over-exposure to any chemical can be unhealthful, many low levels of chemicals are effective and beneficial. In the case of spa water, the chemicals recommended in the **HOT SPOT** Spa Water Maintenance program are needed to protect the user from water-borne pathogens (disease-causing microbes) and to prevent corrosion of spa components.

**Question:** Why isn't water chemistry damage covered by the warranty?

**Answer:** The chemical levels and water quality of the water in the spa are under your direct control. With proper basic care, the spa will provide many years of hot water relaxation. If you are unsure about any chemical or its usage in the spa, contact your Authorized Dealer or Watkins Manufacturing Corporation.

# WATER TERMINOLOGY

The following chemical terms are used in this Water Quality and Maintenance section. Understanding their meaning will help you to better understand the water maintenance process.

**Bromamines:** Compounds formed when bromine combines with nitrogen from body oils, urine, perspiration, etc. Unlike chloramines, bromamines have no pungent odor and are effective sanitizers.

**Bromine:** A halogen sanitizer (in the same chemical family as chlorine). Bromine is commonly used in stick, tablet, or granular form. See the DOs and DON'Ts of Spa Water Maintenance for additional information.

**Calcium Hardness:** The amount of dissolved calcium in the spa water. This should be approximately 50-150 ppm. High levels of calcium can cause cloudy water and scaling. Low levels can cause harm to the spa equipment.

**Chloramines:** Compounds formed when chlorine combines with nitrogen from body oils, urine, perspiration, etc. Chloramines can cause eye irritation as well as having a strong odor. Unlike bromamines, chloramines are weaker, slower sanitizers.

**Chlorine:** An efficient sanitizing chemical for spas. Watkins Manufacturing Corporation recommends the use of sodium dichlor-type granulated chlorine. This type is preferred because it is totally soluble and nearly pH neutral.

**Chlorine (or Bromine) Residual:** The amount of chlorine or bromine remaining after chlorine or bromine demand has been satisfied. The residual is, therefore, the amount of sanitizer which is chemically available to kill bacteria, viruses and algae.

**Corrosion:** The gradual wearing away of metal spa parts, usually caused by chemical action. Generally, corrosion is caused by low pH or by water with levels of TA, CH, pH or sanitizer which are outside the recommended ranges.

**DPD:** The preferred reagent used in test kits to measure the Free Available Chlorine.

**Halogen:** Any one of these five elements: fluorine, chlorine, bromine, iodine and astatine.

**MPS:** Monopersulfate is the non-chlorine oxidizer used with the **FRESHWATER<sub>Ag+</sub>** silver ion purification system.

**Oxidizer:** The use of an oxidizing chemical is to prevent the buildup of contaminants, maximize sanitizer efficiency, minimize combined chlorine, and improve water clarity.

**Pathogen:** A microorganism such as bacterium that cause disease.

**pH:** The measure of the spa water's acidity and alkalinity. The recommended pH for the spa water is 7.2 to 7.6. Below 7.0 (considered neutral), the spa water is too acidic and can damage the heating system. Above 7.8, the water is too alkaline and can result in cloudy water and scale formation on the shell and heater.

**ppm:** The abbreviation of "parts per million", the standard measurement of chemical concentration in water. Identical to mg/l (milligrams per liter).

**Reagent:** A chemical material in liquid, powder, or tablet form for use in chemical testing.

**Sanitizer:** Sanitizers are added and maintained at recommended residuals to protect bathers against pathogenic organisms which can cause disease and infection in spa water.

**Scale:** Rough calcium-bearing deposits that can coat spa surfaces, heaters, plumbing lines and clog filters. Generally, scaling is caused by mineral content combined with high pH. Additionally, scale forms more readily at higher water temperatures.

**Shock Treatment:** Also known as "super-chlorination" when chlorine is used. Shock treatment is a process of adding significant doses of a quick dissolving sanitizer (sodium dichlor is recommended) to oxidize non-filterable organic waste and to remove chloramines and bromamines.

**Total Alkalinity:** The amount of bicarbonates, carbonates, and hydroxides present in spa water. Proper total alkalinity is important for pH control. If the TA is too high, the pH is difficult to adjust. If the TA is too low, the pH will be difficult to hold at the proper level. The desired range of TA in spa water is 40 to 120 ppm.

## MAINTENANCE AND SPA CARE

### FILTER MAINTENANCE

At least once a week, check and clean the skimmer basket and weir to ensure proper filter flow. Remove leaves, foreign matter, and debris. It is very important to keep your spa filter cartridge clean and free of particles to ensure proper water flow. A clean filter permits the hydrotherapy system to function properly and also allows more efficient filter cycles. Depending on how frequently your spa is used, we recommend cleaning the spa filter cartridge every four weeks. If this is not done, the filter may clog and restrict water flow, which causes improper filtration and poor jet performance.

⚠ **WARNING:** The frequency and duration of use, and the number of occupants all contribute to determining the appropriate time between filter cleanings. More use means that more frequent filter cleanings will be required.

## FILTER CARTRIDGE REMOVAL AND CLEANING

1. Disconnect the spa from the power supply by turning the power to the spa OFF.
2. Remove any floating items from within the filter compartment.
3. Turn the filter retainer handle (located on the top of the filter cartridge) counterclockwise until the retainer can be removed from the filter standpipe.
4. Remove the filter retainer, cover and cartridge (cover only used on **TEMPO, RELAY & RHYTHM** spa models).

**SERVICE NOTE:** Never remove the filter standpipe when debris is present in the filter compartment. Debris may find its way into the internal plumbing which may result in blockage. **NEVER REMOVE SUCTION FITTINGS!**

5. Always clean the filter using a filter degreaser, such as **HOT SPRING FRESHWATER** Filter Cleaner, to remove mineral and oil build-up. Simply soak the filter in the degreaser according to the package directions, then place the filter on a clean surface and spray until clean using a garden hose. It may be necessary to rotate the filter while spraying to remove any debris lodged between the filter pleats.
6. To reinstall the filter cartridge, reverse the order of steps in which it was removed. Do not overtighten.

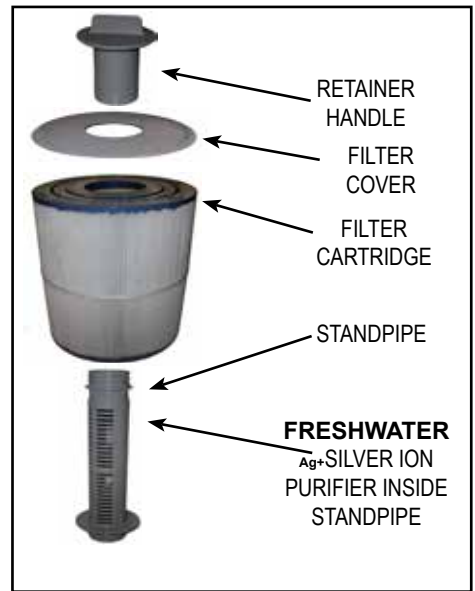

## CARE OF THE SPA PILLOWS

The spa pillows will provide years of comfort if treated with care. They have been positioned above the water level to minimize the bleaching effects of chlorinated water and other spa water chemicals. To extend their life, whenever the spa shell is being cleaned, the spa pillows should be removed and cleaned. Body oils can be removed with a mild soap and water solution. **ALWAYS** rinse off the spa pillows thoroughly to remove any soap residue. If the spa is not going to be used for a long period of time (that is during a vacation or if the spa is winterized), or when the spa water is being super-chlorinated, the spa pillows should be removed until the next use of the spa.

### To remove and replace the spa pillows:

1. Carefully lift one end of the pillow away from the spa shell.
2. Continue lifting one end until all pillow retainers are released from the pillow.  
**IMPORTANT:** Just pulling the pillow straight up and out of the shell recess will eventually damage the pillow. This abuse is not covered under warranty.
3. To reinstall the spa pillow, carefully bend the pillow slightly to allow one of the pillow retainers to slip into the recess in the back of the pillow.
4. Keeping the pillow slightly bent, slide the other pillow retainer into the recess in the back of the pillow.
5. After all the pillow retainers are in place, press the pillow down into the recess in the spa shell.

## CARE OF THE SPA SHELL

Your **HOT SPOT** spa has an acrylic shell. Stains and dirt generally will not adhere to your spa's surface. A soft rag should easily remove most dirt. Most household chemicals are harmful to your spa's shell (see below for detailed information on cleaning agents). Always rinse off any spa shell cleaning agent with fresh water.

### IMPORTANT:

1. The following products are the **ONLY** approved cleaning agents for your **HOT SPOT** spa shell: plain water, **FRESHWATER Spa Shine**, **Brillianize®** or **Soft Scrub®**. The use of alcohol or any other household cleaner other than those listed to clean the spa shell surface is **NOT** recommended. **DO NOT** use any cleaning products containing abrasives or solvents since they may damage the shell surface, specifically: **Simple Green®, Windex®** or **Spa Mitt**. **NEVER USE HARSH CHEMICALS!** Damage to the shell by use of harsh chemicals is not covered under the warranty. Always rinse off any spa shell cleaning agent with fresh water.
2. Iron and copper in the water can stain the spa shell if allowed to go unchecked. Ask your **HOT SPOT** dealer about a Stain and Scale Inhibitor to use if your spa has a high concentration of dissolved minerals. (Watkins recommends **FRESHWATER Stain & Scale Defense**.)
3. Keep all cleaners out of the reach of children and use care when applying.

## CARE OF THE SPA COVER

⚠ **WARNING:** The cover is a manual safety cover that meets or exceeds all prevailing requirements of ASTM Standards for spa safety covers when installed and used correctly as of the date of manufacture. Non-secured or improperly secured covers are a hazard. Open the cover to its fully open position before use.

The vinyl spa cover is an attractive, durable foam insulation product. Monthly cleaning and conditioning are recommended to maintain its beauty.

## **To clean and condition the vinyl cover:**

1. Remove the cover from the spa and gently lean it against a wall or fence.
2. With a garden hose, spray the cover to loosen and rinse away dirt or debris.
3. Using a large sponge and/or a soft bristle brush, and using a very mild soap solution (1 teaspoon dishwashing liquid with 2 gallons (8 liters) of water) or baking soda (sodium bicarbonate), scrub the vinyl top in a circular motion. Do not let the vinyl dry with a soap film on it before it can be rinsed clean.
4. Scrub the cover's perimeter and side flaps. Rinse clean with water.
5. Rinse off the underside of the cover with water only (use no soap), and wipe it clean with a dry rag.

**SERVICE NOTE:** To remove tree sap, use cigarette lighter fluid (not charcoal lighter fluid). Use sparingly, and rinse with a saddle soap solution immediately afterwards, then wipe dry.

## **Important reminders:**

- **DO** remove snow buildup to avoid breakage of the foam core from the additional weight of the snow.
- **DO** lock cover lock straps to secure the cover when the spa is not in use.
- **DO NOT** drag or lift the spa cover using either the flaps or the cover lock straps.
- **DO NOT** walk, stand, or sit on the cover.
- **DO NOT** place any metal or heat transferring object on the cover or place any type of plastic tarp or drop cloth over the cover as this may result in a melted foam core, which would not be covered under the warranty.
- **DO NOT** use any lifting mechanisms, chemicals or cleaners except those recommended by Watkins Manufacturing Corporation or its Authorized Sales and Service Dealer.

## **CARE OF THE SPA CABINET**

The simulated wood cabinet consists of a rigid polymer that combines the durability of plastic, with the beauty of wood. Simulated wood won't crack, peel, blister, or delaminate even after prolonged exposure to the elements.

Cleaning of simulated wood consists of simply spraying the cabinet with a mild soap and water solution to remove any stains and residue.

## **DRAINING YOUR SPA**

1. **TURN OFF OR DISCONNECT POWER FROM THE SPA.**
2. Locate the drain valve for the spa (lower front of the spa) and remove the drain cap. Attach the inlet of a garden hose to the drain valve (to avoid flooding of the foundation surrounding the spa) and route the outlet of the hose to an appropriate draining area. Spa water with a high sanitizer level may harm plants and grass.
3. Open the valve by turning the knob. The spa will drain by gravitational flow.

**IMPORTANT:** All **HOT SPOT** spa models will drain almost completely through the main drain valve. Equipment such as the jet pump and heating system will drain. Any water remaining within the plumbing or equipment after draining will only need to be removed if the spa is being winterized.

4. After your spa is empty, clean the shell and filter cartridge.
5. After cleaning, close the drain valve, remove garden hose and put drain cap back in place.

## **NON-OPERATION IN COLD CLIMATE**

If the spa is to be left unused for an extended period of time in areas where FREEZING TEMPERATURES **DO NOT** OCCUR, it may be desirable to turn the heater to the lowest temperature. The automatic filter cycles will keep the spa water clean and sparkling. When preparing the spa for use, check the water chemistry to assure correct chlorine or bromine and pH levels.

You can keep the water in the spa during the time of year when freezing at the spa location may occur. If a freeze condition is detected, the pump and heater will be activated automatically to circulate the water in low speed. However, CAUTION must be used with this approach. In the event of electrical power interruption, regardless of the cause, the heater and pump will stop operating and freeze protection will be lost, possibly resulting in freeze damage to the spa, spa plumbing and/or components. Such damage is not covered by warranty.



## PREVENTION OF FREEZING

Your spa has been designed and engineered for year-round use in any climate. In some areas, extremely cold temperatures (below 10°F) combined with strong wind, may cause partial freezing of the jet pump, even though the water inside the spa remains at the selected temperature. The energy efficiency of the spa may also decrease during these cold periods, as the heater will cycle more frequently. As an additional precaution against partial freezing of some of the components, the equipment compartment can be insulated with an insulating kit (available from your local dealer). This insulating kit will also help to maximize the spa's energy efficiency.

**NOTE:** When warmer weather returns (approx. 60°-70°F, 15.5°-21°C), the insulating kit must be removed to prevent overheating of the jet pump.

## WINTERIZING YOUR SPA

If you leave the spa unused for a long period of time in severely cold weather, you should drain the spa and winterize it to avoid accidental freezing due to a power or equipment failure.

**Danger:** Use only Propylene Glycol as your anti-freeze (available at most RV or marine supply stores). This is non-toxic. Never use an automobile anti-freeze (Ethylene Glycol) since it is toxic!

**Warning:** Failure to follow these instructions correctly can lead to freeze damage not covered by warranty. It is strongly recommended that you contact your local dealer to perform this service

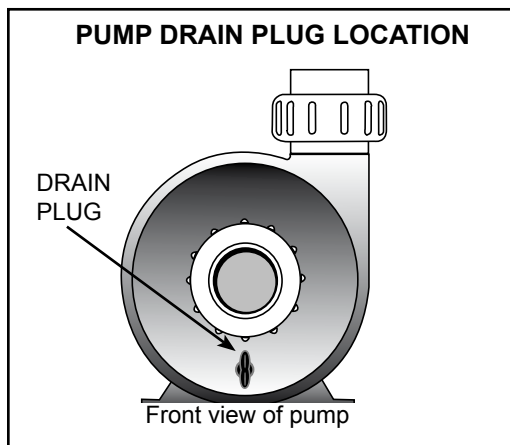

1. Drain your spa following the Draining Your Spa section in the owner's manual.
2. Remove the filter cartridge, clean and store in a dry place.  
**IMPORTANT:** These additional instructions must be utilized when draining and winterizing your spa in climates where the temperature falls below 32°F (0°C). A five (5) gallon (19 liters) combination (vacuum/blower) wet/dry shop vac must be used to effectively remove water that is trapped inside the plumbing lines.
3. Attach the vacuum hose to the vacuum side of the shop vac. Vacuum all openings and orifices as follows:
  - a) Jet openings: start with the jets at the top and move downward (if suction is coming from another jet, block off the other jet using a large rag – this will help pull out the water that is trapped deeper inside the main line).
  - b) Filter suction fittings and filter compartment.
  - c) Main drain outlet (it may be necessary to cover the drain grate tightly with a rag when vacuuming the main drain to ensure water is drawn completely from the internal plumbing system).
4. Thoroughly dry the spa shell with a clean towel.
5. Replace the main drain cap.

**CAUTION:** Use only Propylene Glycol as your anti-freeze. This is non-toxic. Never use an automobile anti-freeze (Ethylene Glycol) since it is toxic!

6. Using a long-extension funnel, pour anti-freeze into all standpipes, filter suction fittings, jet orifices and water feature orifices. Add enough anti-freeze to ensure adequate protection – in many cases, you will see the liquid in the orifice, or coming out of another location.
7. Close the spa cover and fasten the cover tie downs. Cover the spa cover with two pieces of plywood to evenly distribute the weight of snow and ice. Secure a plastic sheet, or tarp, over the spa cover and plywood.
8. Replace the equipment access door, if removed.

## OPENING INSTRUCTIONS:

1. Remove plywood and plastic sheet. Open the spa cover by unfastening the cover tie downs.
2. Follow the Start-up and Refill Procedures in the Operating Instructions section of the Owner's Manual. Do not install filters to prevent them from exposure to the anti-freeze.
3. As part of this process, superchlorinate the spa water by adding three teaspoons of chlorine (sodium dichlor) per 250 gallons of spa water into the filter compartment. This is twice the normal amount of chlorine needed for superchlorination. This extra amount of chlorine is needed to destroy the anti-freeze.

**NOTE:** A defoamer may be needed to decrease the amount of foam caused by the anti-freeze.

4. Drain your spa to ensure removal of anti-freeze. Do not drain water on grass or plants due to excessive chlorine level.
5. After the spa has completely drained, re-install your filter and follow the Start-up and Refill Procedures in the Operating Instructions section of the Owner's Manual.

**IMPORTANT:** Always keep spa covered when not in use, whether it is empty or full.

# SERVICE INFORMATION

## GENERAL INFORMATION

Your **HOT SPOT** spa has been designed to provide years of trouble-free use. As with any appliance, problems may occasionally occur that require the expertise of a qualified service person. Though such simple repairs as resetting a GFCI switch or breaker, high limit thermostat, or pressure switch, or replacing a light bulb may not require a service call, they may indicate that a more serious condition exists. These conditions may require an experienced service person. Before calling for service, please refer to the Troubleshooting Guide.

**NOTE:** Always retain your original sales receipt for future reference.

## GFCI AND HIGH-LIMIT THERMOSTAT

If your spa fails to operate at any time, the following items should be checked:

1. Check the power supply to the spa.
2. Check the GFCI (located at the end of the cord in standard models or in the electrical subpanel in 30 amp converted models) and see if it has tripped. If a GFCI has tripped, reset it. If it will not reset, this may be an indication of a ground fault (short circuit) within the electrical components. Contact an Authorized Service Technician for a complete diagnosis.
3. If, upon checking the GFCI you find it has not tripped, check the house breaker panel and ensure the main breaker for the electrical circuit supplying the spa has not tripped. If it has, this is an indication that either the circuit was overloaded or a ground fault exists between the breaker panel and the spa receptacle. Contact a qualified electrician.
4. If, upon checking the main house breaker, you find no failures, the heater high-limit thermostat should be checked. Tripping of the heater high-limit thermostat is normally a result of one or a combination of any of these problems: 1) blockage within the system plumbing, 2) switch malfunction in the heater circuit, or 3) the low speed mode of the jet pump is not functioning.
5. If the heater high-limit has tripped, the control panel display will display - - - -. Reset the heater high-limit by allowing the water to cool and disconnecting power to the spa for at least thirty seconds. If the heater high-limit continues to trip, contact an Authorized Service Technician for a complete diagnosis.

If the spa does not function and the GFCI or GFCI breaker and heater high-limit have not tripped, then the problem should be referred to an Authorized Service Technician. Refer to the Troubleshooting Guide for additional service information.

## MISCELLANEOUS SERVICE INFORMATION

The jet pump is equipped with an overload cut-off switch, which is designed to protect the pump from overheating. If the pump shuts itself off in a new spa, it is usually the result of one, or a combination of, the following factors:

**High Temperature:** During the summer months, especially in warmer climates, the ambient temperature contributes to excessively high temperatures within the equipment compartment.

**Improper House Wiring:** If the spa is not connected to a dedicated circuit, or is connected to an extension cord, or the house wiring is undersized, the pump may starve for voltage and therefore may draw more amperage and generate excessive heat. This will often cause the circuit breaker to trip repeatedly.

### **IMPORTANT:**

1. If the pump is shutting down due to excessive heat, make sure the equipment compartment has adequate ventilation. The air gap at the bottom and the jet pump vent at the bottom left corner must not be blocked. Should your jet pump continue to shut off after short periods of use, contact a qualified service technician.
2. The **HOT SPOT** spa is equipped with a safety suction spring valve which will break the prime of the jet pump if both suction fittings are obstructed.

## ACTS INVALIDATING WARRANTY

The limited warranty is void if the **HOT SPOT** Spa has been subjected to alteration, misuse or abuse, or if any repairs on the spa are attempted by anyone other than an authorized representative of Watkins Manufacturing Corporation. Alteration is defined as any component or plumbing change, electrical conversion, or the addition of any non-approved sanitation, or water purification device, or heating system which contributes to a component failure, unit failure, or unsafe operating condition. Misuse and abuse shall include any operation of the spa other than in accordance with Watkins Manufacturing Corporation printed instructions, or use of the spa in an application for which it is not designed; specifically: use of the spa in a non-residential application; damage caused by operation\* of the spa at water temperatures outside the range of 35°F and 120°F (2°C and 49°C); damage caused by a dirty, clogged, or calcified filter cartridge; damage to the spa surface caused by the use of Tri-Chloro Chlorine, BCDMH, chemical tablets in a floater, acid, or any other spa chemicals, or spa surface cleaners which are not recommended by Watkins Manufacturing Corporation; damage caused by allowing undissolved spa sanitizing chemicals to lie on the spa surface (no spa surface material can withstand this kind of abuse); damage to components or spa surface caused by improper water chemistry maintenance; and damage to the spa surface caused by leaving the spa uncovered while empty of water and in direct exposure to sunlight (this may cause solar heating distress in warm weather regions). These are considered abuses and may invalidate this warranty.

\*Operation of the spa **DOES NOT** mean “use” of the spa! Watkins Manufacturing Corporation does not recommend using the spa if the water temperature is above or below the spa’s control panel temperature range.

## DISCLAIMERS

Watkins Manufacturing Corporation shall not be liable for loss of use of the **HOT SPOT** spa or other incidental or consequential costs, expenses, or damages, which may include but are not limited to, the removal of a permanent deck or other custom fixture. Any implied warranty shall have a duration equal to the duration of the applicable warranty stated above. Under no circumstances shall Watkins Manufacturing Corporation, or any of its representatives, be held liable for injury to any person, or damage to any property, however arising.

## WATKINS CUSTOMER SERVICE

If you have any questions about any aspect of your **HOT SPOT** spa set-up, operation, or maintenance that have not been answered by this manual, consult your **HOT SPOT** Spa Dealer.

Watkins Manufacturing Corporation can be reached at: 800-999-4688 (Extension 8432), Monday through Friday, 8 am to 5-pm Pacific Standard Time (PST), or e-mail at [Custsvc@watkinsmfg.com](mailto:Custsvc@watkinsmfg.com).

## TROUBLESHOOTING

Watkins Manufacturing Corporation strives to provide the most trouble-free spas on the market. Should you experience any problem whatsoever, do not hesitate to contact your authorized **HOT SPOT** Spa Dealer. Here are some tips to help you to diagnose and rectify some more common sources of trouble yourself, if you choose to do so.

## GENERAL OPERATION TROUBLESHOOTING GUIDE

Problem	Probable causes	Solutions
Entire spa is inoperative.	<ul style="list-style-type: none"> <li>Power failure / not plugged in</li> <li>GFCI tripped</li> </ul>	<ul style="list-style-type: none"> <li>Check power source</li> <li>Reset GFCI; call for service if it will not reset.</li> </ul>
Spa does not heat; jets and light operate. Display shows" =====" POWER & READY icon flashes	<ul style="list-style-type: none"> <li>Pressure switch is open and should be closed</li> <li>Pressure switch senses flow through heater even though the jet pump is off</li> </ul>	<ul style="list-style-type: none"> <li>Check for clogged filter. The pressure switch will reset when the flow of water through the heater has been restored. Call for service if the pressure switch trips frequently.</li> <li>Contact an Authorized Service Technician</li> </ul>
READY icon flashes	<ul style="list-style-type: none"> <li>Control Sensor open or shorted</li> </ul>	<ul style="list-style-type: none"> <li>Contact an Authorized Service Technician</li> </ul>
Spa does not heat; jets and light operate. Display shows" =====" POWER & READY icon flashes	<ul style="list-style-type: none"> <li>Pressure switch is closed and should be open</li> </ul>	<ul style="list-style-type: none"> <li>Contact an Authorized Service Technician</li> </ul>
Jets weak or surging	<ul style="list-style-type: none"> <li>Spa water level too low</li> <li>Filters clogged / suction screens clogged</li> <li>Jet nozzles closed / Air valve closed</li> </ul>	<ul style="list-style-type: none"> <li>Add water</li> <li>Clean filters / Clean suction screens</li> <li>Open jet nozzles / Open air valve</li> </ul>
Light inoperative	<ul style="list-style-type: none"> <li>Bad connection</li> </ul>	<ul style="list-style-type: none"> <li>Contact an Authorized Service Technician</li> </ul>
Display shows "----" (Entire spa is inoperative.) POWER icon flashes	<ul style="list-style-type: none"> <li>Heater high limit thermostat tripped</li> </ul>	<ul style="list-style-type: none"> <li>Disconnect power to the spa for at least thirty seconds to reset the heater high-limit. If tripping continues, clean the filter, then if tripping still occurs, call for service.</li> </ul>
After filling or refilling the spa: a jet pump is operating, but water is not flowing from any of its jets.	<ul style="list-style-type: none"> <li>Pump is not properly primed.</li> </ul>	<ol style="list-style-type: none"> <li>Turn off power to the spa at the breaker and remove the equipment compartment door.</li> <li>Loosen the union on the top of the pump(s) (as seen on page 48) to allow the air to escape, the hand-tighten the union(s).</li> <li>Turn power back on, activate the pump and check to make sure union is tight enough to keep it from leaking. Re-install pump and equipment doors.</li> </ol>

## SPA WATER MAINTENANCE TROUBLESHOOTING GUIDE

Problem	Probable causes	Solutions
Cloudy Water	<ul style="list-style-type: none"> <li>Dirty filters</li> <li>Excessive oils / organic matter</li> <li>Improper sanitization</li> <li>Suspended particles / organic matter</li> <li>Overused or old water</li> </ul>	<ul style="list-style-type: none"> <li>Clean filters</li> <li>Shock spa with sanitizer</li> <li>Add sanitizer</li> <li>Adjust pH and/or alkalinity to recommended range</li> <li>Run jet pump(s) and clean filters</li> <li>Drain and refill the spa</li> </ul>
Water Odor	<ul style="list-style-type: none"> <li>Excessive organics in water</li> <li>Improper sanitization</li> <li>Low pH</li> </ul>	<ul style="list-style-type: none"> <li>Shock spa with sanitizer</li> <li>Add sanitizer</li> <li>Adjust pH to recommended range</li> </ul>
Chlorine Odor	<ul style="list-style-type: none"> <li>Chloramine level too high</li> <li>Low pH</li> </ul>	<ul style="list-style-type: none"> <li>Shock spa with sanitizer</li> <li>Adjust pH to recommended range</li> </ul>
Musty Odor	<ul style="list-style-type: none"> <li>Bacteria or algae growth</li> </ul>	<ul style="list-style-type: none"> <li>Shock spa with sanitizer—if problem is visible or persistent, drain, clean and refill the spa</li> </ul>
Organic buildup / scum ring around spa	<ul style="list-style-type: none"> <li>Build-up of oils and dirt</li> </ul>	<ul style="list-style-type: none"> <li>Wipe off scum with clean rag – if severe, drain the spa, use a spa surface and tile cleaner to remove the scum, and refill the spa</li> </ul>
Algae Growth	<ul style="list-style-type: none"> <li>High pH</li> <li>Low sanitizer level</li> </ul>	<ul style="list-style-type: none"> <li>Shock spa with sanitizer and adjust pH</li> <li>Shock spa with sanitizer and maintain sanitizer level</li> </ul>
Eye Irritation	<ul style="list-style-type: none"> <li>Low pH</li> <li>Low sanitizer level</li> </ul>	<ul style="list-style-type: none"> <li>Adjust pH</li> <li>Shock spa with sanitizer and maintain sanitizer level</li> </ul>
Skin Irritation / Rash	<ul style="list-style-type: none"> <li>Unsanitary water</li> <li>Free chlorine level above 5 ppm</li> </ul>	<ul style="list-style-type: none"> <li>Shock spa with sanitizer and maintain sanitizer level</li> <li>Allow free chlorine level to drop below 5 ppm before spa use</li> </ul>
Stains	<ul style="list-style-type: none"> <li>Total alkalinity and/or pH too low</li> <li>High iron or copper in source water</li> </ul>	<ul style="list-style-type: none"> <li>Adjust total alkalinity and/or pH</li> <li>Use a metal deposit inhibitor</li> </ul>
Scale	<ul style="list-style-type: none"> <li>High calcium content in water – total alkalinity and pH too high</li> </ul>	<ul style="list-style-type: none"> <li>Adjust total alkalinity and pH – if scale requires removal, drain the spa, scrub off the scale, refill the spa and balance the water</li> </ul>

# PRIMING THE PUMP(S)

Upon filling or refilling the spa, if a pump is operating and water is not flowing from any of its jets, the pump may not be properly primed. To correct, refer to the illustration below and perform the following procedures:

- Turn off power to the spa at the breaker and remove the equipment compartment door.
- **Loosen** the union on the top of the pump(s) to allow the air to escape. When water is present, hand-tighten the union.
- Turn power back on, activate the pump and check to make sure union is tight enough to keep it from leaking. Re-install equipment door.

**NOTE:** Equipment compartment illustrated below will vary depending on spa model.

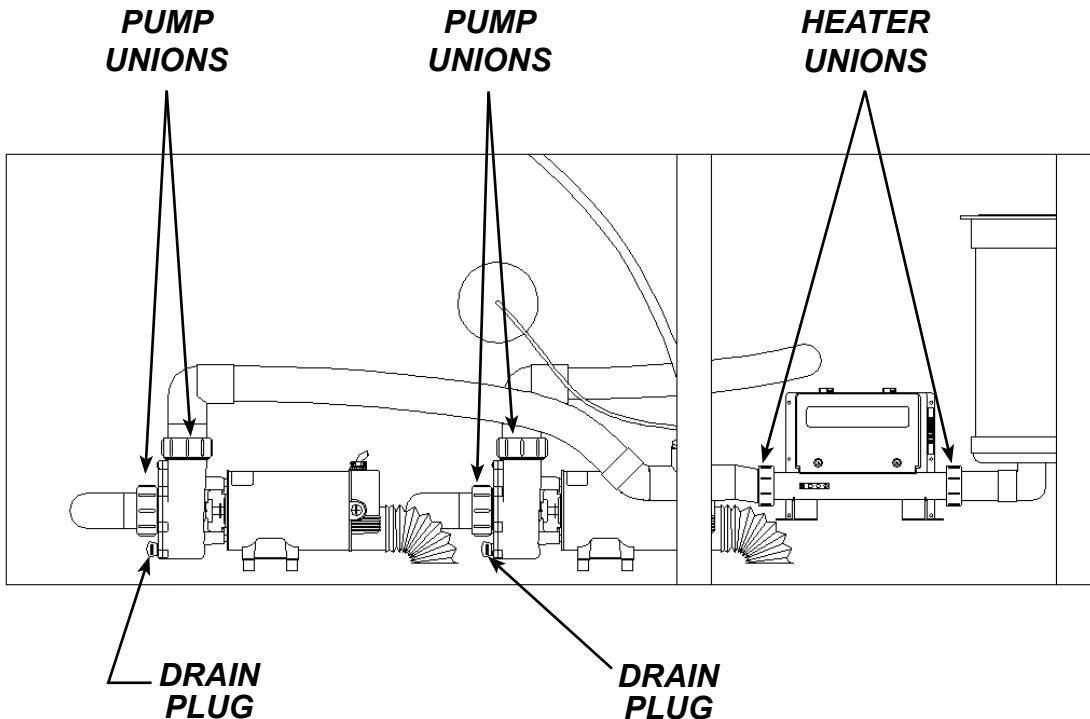

## **IMPORTANT**

**THE DRAIN CAP AND UNION FITTINGS IN THE EQUIPMENT COMPARTMENT MAY LOOSEN DURING TRANSPORTATION. TO AVOID LEAKS, PLEASE CHECK TO MAKE SURE THESE ARE HAND-TIGHT PRIOR TO FILLING YOUR SPA.**

This manual contains installation, operating, maintenance and service information for the following 2015 HOT SPOT Spa models:

US/CANADIAN MODELS

<b>TEMPO</b>	(MODEL TEM)
<b>RELAY</b>	(MODEL REL)
<b>RHYTHM</b>	(MODEL RHY/RHYC)
<b>SX</b>	(MODEL SX/SXC)
<b>TX</b>	(MODEL TX/TXC)

©2015 Watkins Manufacturing Corporation All Rights Reserved. Hot Spot, Tempo, Relay, Rhythm, Precision, No-Fault, FreshWater, FreshWater<sub>Ag+</sub>, EverFresh, Clean Screen and Vanishing Act are trademarks of Watkins Manufacturing Corporation. BaquaSpa is a trademark of Arch UK Biocides Limited. Brominating Concentrate is a trademark of Bio-Lab Inc. iPod is a trademark of Apple, Inc.

From the makers of



Watkins Manufacturing Corporation  
Vista, California USA

